

Pocket Manual

Service Diagnosis *VRV*



Большая библиотека технической документации
<http://splitoff.ru/tehn-doc.html>
каталоги, инструкции, сервисные мануалы, схемы.

VRV Series

1. Troubleshooting by Remote Controller	15
1.1 The INSPECTION / TEST Button	15
1.2 Self-diagnosis by Wired Remote Controller	16
1.3 Self-diagnosis by Wireless Remote Controller	17
1.4 Operation of the Remote Controller's Inspection / Test Operation Button	21
1.5 Remote Controller Service Mode	22
1.6 Remote Controller Self-diagnosis Function	25
2. Troubleshooting by Indication on the Remote Controller	50

■ Included Series	Applicable models (page)
VRV II M(A) Series	3
VRV II-S M Series	5
VRV W II M Series	6
VRV III P Series 50Hz.....	7
VRV III P Series 60Hz.....	9
VRV III P Series H/R	10
VRV III P Series C/O	11
VRV III-S P Series 50Hz	12
VRV III-S P Series 50/60Hz	13

Applicable Models

1. VRV II M(A) Series

Indoor Units

FXAQ20MHV1	FXCQ80MVE	FXFQ50MVE	FXLQ32MVE	FXNQ40MVE
FXAQ20MVE	FXCQ125MVE	FXFQ63MVE	FXLQ40MHV1	FXNQ50MVE
FXAQ25MHV1	FXDQ20NVE	FXFQ80MVE	FXLQ40MVE	FXNQ63MVE
FXAQ25MVE	FXDQ20NVET	FXFQ100MVE	FXLQ50MHV1	FXSQ20MVE
FXAQ32MHV1	FXDQ25NVE	FXFQ125MVE	FXLQ50MVE	FXSQ25MVE
FXAQ32MVE	FXDQ25NVET	FXHQ32MVE	FXLQ63MVE	FXSQ32MVE
FXAQ40MHV1	FXDQ32NVE	FXHQ63MVE	FXMQ40MVE	FXSQ40MVE
FXAQ40MVE	FXDQ32NVET	FXHQ100MVE	FXMQ50MVE	FXSQ50MVE
FXAQ50MHV1	FXDQ40NVE	FXKQ25MVE	FXMQ63MVE	FXSQ63MVE
FXAQ50MVE	FXDQ40NVET	FXKQ32MVE	FXMQ80MVE	FXSQ80MVE
FXAQ63MVE	FXDQ50NVE	FXKQ40MVE	FXMQ100MVE	FXSQ100MVE
FXCQ20MVE	FXDQ50NVET	FXKQ63MVE	FXMQ125MVE	FXSQ125MVE
FXCQ25MVE	FXDQ63NVE	FXLQ20MHV1	FXMQ200MVE	FXUQ71MV1
FXCQ32MVE	FXDQ63NVET	FXLQ20MVE	FXMQ250MVE	FXUQ100MV1
FXCQ40MVE	FXFQ25MVE	FXLQ25MHV1	FXNQ20MVE	FXUQ125MV1
FXCQ50MVE	FXFQ32MVE	FXLQ25MVE	FXNQ25MVE	
FXCQ63MVE	FXFQ40MVE	FXLQ32MHV1	FXNQ32MVE	

Outdoor Units

RXQ5MAY1	RXQ42MAY1	RXYQ14MAYL	RXYQ26MAYL	RXYQ38MAYL
RXQ8MAY1	RXQ44MAY1	RXYQ16MATL	RXYQ28MATL	RXYQ40MATL
RXQ10MAY1	RXQ46MAY1	RXYQ16MAY1	RXYQ28MAY1	RXYQ40MAY1
RXQ12MAY1	RXQ48MAY1	RXYQ16MAYL	RXYQ28MAYL	RXYQ40MAYL
RXQ14MAY1	RXYQ5MATL	RXYQ18MATL	RXYQ30MATL	RXYQ42MATL
RXQ16MAY1	RXYQ5MAY1	RXYQ18MAY1	RXYQ30MAY1	RXYQ42MAY1
RXQ18MAY1	RXYQ5MAYL	RXYQ18MAYL	RXYQ30MAYL	RXYQ42MAYL
RXQ20MAY1	RXYQ8MATL	RXYQ20MATL	RXYQ32MATL	RXYQ44MATL
RXQ22MAY1	RXYQ8MAY1	RXYQ20MAY1	RXYQ32MAY1	RXYQ44MAY1
RXQ24MAY1	RXYQ8MAYL	RXYQ20MAYL	RXYQ32MAYL	RXYQ44MAYL
RXQ26MAY1	RXYQ10MATL	RXYQ22MATL	RXYQ34MATL	RXYQ46MATL
RXQ28MAY1	RXYQ10MAY1	RXYQ22MAY1	RXYQ34MAY1	RXYQ46MAY1
RXQ30MAY1	RXYQ10MAYL	RXYQ22MAYL	RXYQ34MAYL	RXYQ46MAYL
RXQ32MAY1	RXYQ12MATL	RXYQ24MATL	RXYQ36MATL	RXYQ48MATL
RXQ34MAY1	RXYQ12MAY1	RXYQ24MAY1	RXYQ36MAY1	RXYQ48MAY1
RXQ36MAY1	RXYQ12MAYL	RXYQ24MAYL	RXYQ36MAYL	RXYQ48MAYL
RXQ38MAY1	RXYQ14MATL	RXYQ26MATL	RXYQ38MATL	
RXQ40MAY1	RXYQ14MAY1	RXYQ26MAY1	RXYQ38MAY1	

BS Units

BEVQ50MVE
BEVQ71MVE
BEVQ100MVE
BEVQ125MVE

2. VRV II-S M Series

Indoor Units

FXAQ20MVE	FXDQ20NVE	FXHQ32MVE	FXMQ50MVE	FXSQ40MVE
FXAQ25MVE	FXDQ25NVE	FXHQ63MVE	FXMQ63MVE	FXSQ50MVE
FXAQ32MVE	FXDQ32NVE	FXHQ100MVE	FXMQ80MVE	FXSQ63MVE
FXAQ40MVE	FXDQ40NVE	FXXQ25MVE	FXMQ100MVE	FXSQ80MVE
FXAQ50MVE	FXDQ50NVE	FXXQ32MVE	FXMQ125MVE	FXSQ100MVE
FXAQ63MVE	FXDQ63NVE	FXXQ40MVE	FXNQ20MVE	FXSQ125MVE
FXCQ20MVE	FXFQ25MVE	FXXQ63MVE	FXNQ25MVE	FXZQ20MVE
FXCQ25MVE	FXFQ32MVE	FXLQ20MVE	FXNQ32MVE	FXZQ25MVE
FXCQ32MVE	FXFQ40MVE	FXLQ25MVE	FXNQ40MVE	FXZQ32MVE
FXCQ40MVE	FXFQ50MVE	FXLQ32MVE	FXNQ50MVE	FXZQ40MVE
FXCQ50MVE	FXFQ63MVE	FXLQ40MVE	FXNQ63MVE	FXZQ50MVE
FXCQ63MVE	FXFQ80MVE	FXLQ50MVE	FXSQ20MVE	
FXCQ80MVE	FXFQ100MVE	FXLQ63MVE	FXSQ25MVE	
FXCQ125MVE	FXFQ125MVE	FXMQ40MVE	FXSQ32MVE	

Outdoor Units

RXYMQ4MV4A
RXYMQ5MV4A
RXYMQ6MV4A

3. VRV W II M Series

Indoor Units

FXAQ20MAVE	FXDQ20PVE	FXFQ25MVE	FXLQ25MAVE	FXNQ40MAVE
FXAQ25MAVE	FXDQ20PVET	FXFQ32MVE	FXLQ32MAVE	FXNQ50MAVE
FXAQ32MAVE	FXDQ25NAVE	FXFQ40MVE	FXLQ40MAVE	FXNQ63MAVE
FXAQ40MAVE	FXDQ25NVET	FXFQ50MVE	FXLQ50MAVE	FXSQ20MVE
FXAQ50MAVE	FXDQ25PVE	FXFQ63MVE	FXLQ63MAVE	FXSQ25MVE
FXAQ63MAVE	FXDQ25PVET	FXFQ80MVE	FXMQ40MAVE	FXSQ32MVE
FXCQ20MVE	FXDQ32NAVE	FXFQ100MVE	FXMQ50MAVE	FXSQ40MVE
FXCQ25MVE	FXDQ32NVET	FXFQ125MVE	FXMQ63MAVE	FXSQ50MVE
FXCQ32MVE	FXDQ32PVE	FXHQ32MAVE	FXMQ80MAVE	FXSQ63MVE
FXCQ40MVE	FXDQ32PVET	FXHQ63MAVE	FXMQ100MAVE	FXSQ80MVE
FXCQ50MVE	FXDQ40NAVE	FXHQ100MAVE	FXMQ125MAVE	FXSQ100MVE
FXCQ63MVE	FXDQ40NVET	FXKQ25MAVE	FXMQ200MAVE	FXSQ125MVE
FXCQ80MVE	FXDQ50NAVE	FXKQ32MAVE	FXMQ250MAVE	
FXCQ125MVE	FXDQ50NVET	FXKQ40MAVE	FXNQ20MAVE	
FXDQ20NAVE	FXDQ63NAVE	FXKQ63MAVE	FXNQ25MAVE	
FXDQ20NVET	FXDQ63NVET	FXLQ20MAVE	FXNQ32MAVE	

Outdoor Units

RWEYQ10MTL
RWEYQ10MYL
RWEYQ20MTL
RWEYQ20MYL
RWEYQ30MTL
RWEYQ30MYL

BS Units

BSVQ36MVJU
BSVQ60MVJU

4. VRV III P Series 50Hz

Indoor Units

FXAQ20MAVE	FXDQ25NAVE	FXFQ63MVE	FXMQ50MAVE	FXSQ32MVE
FXAQ25MAVE	FXDQ25NVET	FXFQ80MVE	FXMQ63MAVE	FXSQ40MVE
FXAQ32MAVE	FXDQ25PVE	FXFQ100MVE	FXMQ80MAVE	FXSQ50MVE
FXAQ40MAVE	FXDQ25PVET	FXFQ125MVE	FXMQ100MAVE	FXSQ63MVE
FXAQ50MAVE	FXDQ32NAVE	FXHQ32MAVE	FXMQ125MAVE	FXSQ80MVE
FXAQ63MAVE	FXDQ32NVET	FXHQ63MAVE	FXMQ125MFV1	FXSQ100MVE
FXCQ20MVE	FXDQ32PVE	FXHQ100MAVE	FXMQ200MAVE	FXSQ125MVE
FXCQ25MVE	FXDQ32PVET	FXKQ25MAVE	FXMQ200MFV1	FXUQ71MAV1
FXCQ32MVE	FXDQ40NAVE	FXKQ32MAVE	FXMQ250MAVE	FXUQ100MAV1
FXCQ40MVE	FXDQ40NVET	FXKQ40MAVE	FXMQ250MFV1	FXUQ125MAV1
FXCQ50MVE	FXDQ50NAVE	FXKQ63MAVE	FXNQ20MAVE	FXZQ20M7V1B
FXCQ63MVE	FXDQ50NVET	FXLQ20MAVE	FXNQ25MAVE	FXZQ25M7V1B
FXCQ80MVE	FXDQ63NAVE	FXLQ25MAVE	FXNQ32MAVE	FXZQ32M7V1B
FXCQ125MVE	FXDQ63NVET	FXLQ32MAVE	FXNQ40MAVE	FXZQ40M7V1B
FXDQ20NAVE	FXFQ25MVE	FXLQ40MAVE	FXNQ50MAVE	FXZQ50M7V1B
FXDQ20NVET	FXFQ32MVE	FXLQ50MAVE	FXNQ63MAVE	
FXDQ20PVE	FXFQ40MVE	FXLQ63MAVE	FXSQ20MVE	
FXDQ20PVET	FXFQ50MVE	FXMQ40MAVE	FXSQ25MVE	

Outdoor Units

RXYQ5PY1	RXYQ18PY1E	RXYQ30PHY1	RXYQ38PHY1E	RXYQ46PY1
RXYQ5PY1E	RXYQ20PY1	RXYQ30PHY1E	RXYQ38PY1	RXYQ46PY1E
RXYQ8PY1	RXYQ20PY1E	RXYQ30PY1	RXYQ38PY1E	RXYQ48PHY1
RXYQ8PY1E	RXYQ22PY1	RXYQ30PY1E	RXYQ40PHY1	RXYQ48PHY1E
RXYQ10PY1	RXYQ22PY1E	RXYQ32PHY1	RXYQ40PHY1E	RXYQ48PY1
RXYQ10PY1E	RXYQ24PHY1	RXYQ32PHY1E	RXYQ40PY1	RXYQ48PY1E
RXYQ12PY1	RXYQ24PHY1E	RXYQ32PY1	RXYQ40PY1E	RXYQ50PHY1
RXYQ12PY1E	RXYQ24PY1	RXYQ32PY1E	RXYQ42PHY1	RXYQ50PHY1E
RXYQ14PY1	RXYQ24PY1E	RXYQ34PHY1	RXYQ42PHY1E	RXYQ50PY1
RXYQ14PY1E	RXYQ26PHY1	RXYQ34PHY1E	RXYQ42PY1	RXYQ50PY1E
RXYQ16PHY1	RXYQ26PHY1E	RXYQ34PY1	RXYQ42PY1E	RXYQ52PY1
RXYQ16PHY1E	RXYQ26PY1	RXYQ34PY1E	RXYQ44PHY1	RXYQ52PY1E
RXYQ16PY1	RXYQ26PY1E	RXYQ36PHY1	RXYQ44PHY1E	RXYQ54PY1
RXYQ16PY1E	RXYQ28PHY1	RXYQ36PHY1E	RXYQ44PY1	RXYQ54PY1E
RXYQ18PHY1	RXYQ28PHY1E	RXYQ36PY1	RXYQ44PY1E	
RXYQ18PHY1E	RXYQ28PY1	RXYQ36PY1E	RXYQ46PHY1	
RXYQ18PY1	RXYQ28PY1E	RXYQ38PHY1	RXYQ46PHY1E	

BS Units

BEVQ71MAVE

BEVQ100MAVE

BEVQ125MAVE

5. VRV III P Series 60Hz

Indoor Units

FXAQ20MAVE	FXDQ20PVET	FXFQ40MVE	FXLQ50MAVE	FXSQ25MVE
FXAQ25MAVE	FXDQ25NAVE	FXFQ50MVE	FXLQ63MAVE	FXSQ32MVE
FXAQ32MAVE	FXDQ25NVET	FXFQ63MVE	FXMQ40MAVE	FXSQ40MVE
FXAQ40MAVE	FXDQ25PVE	FXFQ80MVE	FXMQ50MAVE	FXSQ50MVE
FXAQ50MAVE	FXDQ25PVET	FXFQ100MVE	FXMQ63MAVE	FXSQ63MVE
FXAQ63MAVE	FXDQ32NAVE	FXFQ125MVE	FXMQ80MAVE	FXSQ80MVE
FXCQ20MVE	FXDQ32NVET	FXHQ32MAVE	FXMQ100MAVE	FXSQ100MVE
FXCQ25MVE	FXDQ32PVE	FXHQ63MAVE	FXMQ125MAVE	FXSQ125MVE
FXCQ32MVE	FXDQ32PVET	FXHQ100MAVE	FXMQ200MAVE	FXZQ20M7V1B
FXCQ40MVE	FXDQ40NAVE	FXKQ25MAVE	FXMQ250MAVE	FXZQ25M7V1B
FXCQ50MVE	FXDQ40NVET	FXKQ32MAVE	FXNQ20MAVE	FXZQ32M7V1B
FXCQ63MVE	FXDQ50NAVE	FXKQ40MAVE	FXNQ25MAVE	FXZQ40M7V1B
FXCQ80MVE	FXDQ50NVET	FXKQ63MAVE	FXNQ32MAVE	FXZQ50M7V1B
FXCQ125MVE	FXDQ63NAVE	FXLQ20MAVE	FXNQ40MAVE	
FXDQ20NAVE	FXDQ63NVET	FXLQ25MAVE	FXNQ50MAVE	
FXDQ20NVET	FXFQ25MVE	FXLQ32MAVE	FXNQ63MAVE	
FXDQ20PVE	FXFQ32MVE	FXLQ40MAVE	FXSQ20MVE	

Outdoor Units

RXYP5PYL	RXYP18PYLE	RXYP30PHYL	RXYP38PHYLE	RXYP46PYL
RXYP5PYLE	RXYP20PYL	RXYP30PHYLE	RXYP38PYL	RXYP46PYLE
RXYP8PYL	RXYP20PYLE	RXYP30PYL	RXYP38PYLE	RXYP48PHYL
RXYP8PYLE	RXYP22PYL	RXYP30PYLE	RXYP40PHYL	RXYP48PHYLE
RXYP10PYL	RXYP22PYLE	RXYP32PHYL	RXYP40PHYLE	RXYP48PYL
RXYP10PYLE	RXYP24PHYL	RXYP32PHYLE	RXYP40PYL	RXYP48PYLE
RXYP12PYL	RXYP24PHYLE	RXYP32PYL	RXYP40PYLE	RXYP50PHYL
RXYP12PYLE	RXYP24PYL	RXYP32PYLE	RXYP42PHYL	RXYP50PHYLE
RXYP14PYL	RXYP24PYLE	RXYP34PHYL	RXYP42PHYLE	RXYP50PYL
RXYP14PYLE	RXYP26PHYL	RXYP34PHYLE	RXYP42PYL	RXYP50PYLE
RXYP16PHYL	RXYP26PHYLE	RXYP34PYL	RXYP42PYLE	RXYP52PYL
RXYP16PHYLE	RXYP26PYL	RXYP34PYLE	RXYP44PHYL	RXYP52PYLE
RXYP16PYL	RXYP26PYLE	RXYP36PHYL	RXYP44PHYLE	RXYP54PYL
RXYP16PYLE	RXYP28PHYL	RXYP36PHYLE	RXYP44PYL	RXYP54PYLE
RXYP18PHYL	RXYP28PHYLE	RXYP36PYL	RXYP44PYLE	
RXYP18PHYLE	RXYP28PYL	RXYP36PYLE	RXYP46PHYL	
RXYP18PYL	RXYP28PYLE	RXYP38PHYL	RXYP46PHYLE	

6. VRV III P Series H/R

Indoor Units

FXAQ20MAVE	FXDQ25NAVE	FXDYQ180MV1	FXLQ20MAVE	FXNQ50MAVE
FXAQ25MAVE	FXDQ25NVET	FXDYQ200MV1	FXLQ25MAVE	FXNQ63MAVE
FXAQ32MAVE	FXDQ25PVE	FXDYQ250MV1	FXLQ32MAVE	FXSQ20MVE
FXAQ40MAVE	FXDQ25PVET	FXFQ25MVE	FXLQ40MAVE	FXSQ25MVE
FXAQ50MAVE	FXDQ32NAVE	FXFQ32MVE	FXLQ50MAVE	FXSQ32MVE
FXAQ63MAVE	FXDQ32NVET	FXFQ40MVE	FXLQ63MAVE	FXSQ40MVE
FXCQ20MVE	FXDQ32PVE	FXFQ50MVE	FXMQ40MAVE	FXSQ50MVE
FXCQ25MVE	FXDQ32PVET	FXFQ63MVE	FXMQ50MAVE	FXSQ63MVE
FXCQ32MVE	FXDQ40NAVE	FXFQ80MVE	FXMQ63MAVE	FXSQ80MVE
FXCQ40MVE	FXDQ40NVET	FXFQ100MVE	FXMQ80MAVE	FXSQ100MVE
FXCQ50MVE	FXDQ50NAVE	FXFQ125MVE	FXMQ100MAVE	FXSQ125MVE
FXCQ63MVE	FXDQ50NVET	FXHQ32MAVE	FXMQ125MAVE	FXZQ20M8V1B
FXCQ80MVE	FXDQ63NAVE	FXHQ63MAVE	FXMQ200MAVE	FXZQ25M8V1B
FXCQ125MVE	FXDQ63NVET	FXHQ100MAVE	FXMQ250MAVE	FXZQ32M8V1B
FXDQ20NAVE	FXDYQ80MV1	FXKQ25MAVE	FXNQ20MAVE	FXZQ40M8V1B
FXDQ20NVET	FXDYQ100MV1	FXKQ32MAVE	FXNQ25MAVE	FXZQ50M8V1B
FXDQ20PVE	FXDYQ125MV1	FXKQ40MAVE	FXNQ32MAVE	
FXDQ20PVET	FXDYQ145MV1	FXKQ63MAVE	FXNQ40MAVE	

Outdoor Units

REMQ8PY1	REYQ8PY1E	REYQ20PY1	REYQ30PY1E	REYQ42PY1
REMQ8PY1E	REYQ10PY1	REYQ20PY1E	REYQ32PY1	REYQ42PY1E
REMQ10PY1	REYQ10PY1E	REYQ22PY1	REYQ32PY1E	REYQ44PY1
REMQ10PY1E	REYQ12PY1	REYQ22PY1E	REYQ34PY1	REYQ44PY1E
REMQ12PY1	REYQ12PY1E	REYQ24PY1	REYQ34PY1E	REYQ46PY1
REMQ12PY1E	REYQ14PY1	REYQ24PY1E	REYQ36PY1	REYQ46PY1E
REMQ14PY1	REYQ14PY1E	REYQ26PY1	REYQ36PY1E	REYQ48PY1
REMQ14PY1E	REYQ16PY1	REYQ26PY1E	REYQ38PY1	REYQ48PY1E
REMQ16PY1	REYQ16PY1E	REYQ28PY1	REYQ38PY1E	
REMQ16PY1E	REYQ18PY1	REYQ28PY1E	REYQ40PY1	
REYQ8PY1	REYQ18PY1E	REYQ30PY1	REYQ40PY1E	

BS Units

BSVQ100PV1
BSVQ160PV1
BSVQ250PV1

7. VRV III P Series C/O

Indoor Units

FXAQ20MAVE	FXDQ20PVET	FXFQ40MVE	FXLQ50MAVE	FXNQ50MAVE
FXAQ25MAVE	FXDQ25NAVE	FXFQ50MVE	FXLQ63MAVE	FXNQ63MAVE
FXAQ32MAVE	FXDQ25NVET	FXFQ63MVE	FXMQ40MAVE	FXSQ20MVE
FXAQ40MAVE	FXDQ25PVE	FXFQ80MVE	FXMQ50MAVE	FXSQ25MVE
FXAQ50MAVE	FXDQ25PVET	FXFQ100MVE	FXMQ63MAVE	FXSQ32MVE
FXAQ63MAVE	FXDQ32NAVE	FXFQ125MVE	FXMQ80MAVE	FXSQ40MVE
FXCQ20MVE	FXDQ32NVET	FXHQ32MAVE	FXMQ100MAVE	FXSQ50MVE
FXCQ25MVE	FXDQ32PVE	FXHQ63MAVE	FXMQ125MAVE	FXSQ63MVE
FXCQ32MVE	FXDQ32PVET	FXHQ100MAVE	FXMQ125MFV1	FXSQ80MVE
FXCQ40MVE	FXDQ40NAVE	FXKQ25MAVE	FXMQ200MAVE	FXSQ100MVE
FXCQ50MVE	FXDQ40NVET	FXKQ32MAVE	FXMQ200MFV1	FXSQ125MVE
FXCQ63MVE	FXDQ50NAVE	FXKQ40MAVE	FXMQ250MAVE	FXUQ71MAV1
FXCQ80MVE	FXDQ50NVET	FXKQ63MAVE	FXMQ250MFV1	FXUQ100MAV1
FXCQ125MVE	FXDQ63NAVE	FXLQ20MAVE	FXNQ20MAVE	FXUQ125MAV1
FXDQ20NAVE	FXDQ63NVET	FXLQ25MAVE	FXNQ25MAVE	
FXDQ20NVET	FXFQ25MVE	FXLQ32MAVE	FXNQ32MAVE	
FXDQ20PVE	FXFQ32MVE	FXLQ40MAVE	FXNQ40MAVE	

Outdoor Units

RXP5P1	RXP20P1	RXP30PH1	RXP40P1	RXP48PH1
RXP8P1	RXP22P1	RXP32P1	RXP40PH1	RXP50P1
RXP10P1	RXP24P1	RXP32PH1	RXP42P1	RXP50PH1
RXP12P1	RXP24PH1	RXP34P1	RXP42PH1	RXP52P1
RXP14P1	RXP26P1	RXP34PH1	RXP44P1	RXP54P1
RXP16P1	RXP26PH1	RXP36P1	RXP44PH1	
RXP16PH1	RXP28P1	RXP36PH1	RXP46P1	
RXP18P1	RXP28PH1	RXP38P1	RXP46PH1	
RXP18PH1	RXP30P1	RXP38PH1	RXP48P1	

BS Units

BEVQ71MAVE
BEVQ100MAVE
BEVQ125MAVE

8. VRV III-S P Series 50Hz

Indoor Units

FXAQ20MAVE	FXDQ20PVE	FXFQ100P7VE	FXMQ50MAVE	FXSQ63M8V3
FXAQ25MAVE	FXDQ25M8V4	FXFQ125P7VE	FXMQ63MAVE	FXSQ80M8V3
FXAQ32MAVE	FXDQ25NAVE	FXHQ32MAVE	FXMQ80MAVE	FXSQ100M8V3
FXAQ40MAVE	FXDQ25PVE	FXHQ63MAVE	FXMQ100MAVE	FXSQ125M8V3
FXAQ50MAVE	FXDQ32NAVE	FXHQ100MAVE	FXMQ125MAVE	FXUQ71MAV1
FXAQ63MAVE	FXDQ32PVE	FXKQ25MAVE	FXNQ20MAVE	FXUQ100MAV1
FXCQ20M8V3	FXDQ40NAVE	FXKQ32MAVE	FXNQ25MAVE	FXUQ125MAV1
FXCQ25M8V3	FXDQ50NAVE	FXKQ40MAVE	FXNQ32MAVE	FXZQ20M8V1
FXCQ32M8V3	FXDQ63NAVE	FXKQ63MAVE	FXNQ40MAVE	FXZQ25M8V1
FXCQ40M8V3	FXFQ20P7VE	FXLQ20MAVE	FXNQ50MAVE	FXZQ32M8V1
FXCQ50M8V3	FXFQ25P7VE	FXLQ25MAVE	FXNQ63MAVE	FXZQ40M8V1
FXCQ63M8V3	FXFQ32P7VE	FXLQ32MAVE	FXSQ20M8V3	FXZQ50M8V1
FXCQ80M8V3	FXFQ40P7VE	FXLQ40MAVE	FXSQ25M8V3	
FXCQ125M8V3	FXFQ50P7VE	FXLQ50MAVE	FXSQ32M8V3	
FXDQ20M8V3	FXFQ63P7VE	FXLQ63MAVE	FXSQ40M8V3	
FXDQ20NAVE	FXFQ80P7VE	FXMQ40MAVE	FXSQ50M8V3	

Outdoor Units

RXYSQ4P7Y1B
RXYSQ5P7Y1B
RXYSQ6P7Y1B

9. VRV III-S P Series 50/60Hz

Indoor Units

FXAQ20MAVE	FXDQ20PVE	FXFQ25MVE	FXLQ25MAVE	FXNQ63MAVE
FXAQ25MAVE	FXDQ20PVET	FXFQ32MVE	FXLQ32MAVE	FXSQ20MVE
FXAQ32MAVE	FXDQ25NAVE	FXFQ40MVE	FXLQ40MAVE	FXSQ25MVE
FXAQ40MAVE	FXDQ25NVET	FXFQ50MVE	FXLQ50MAVE	FXSQ32MVE
FXAQ50MAVE	FXDQ25PVE	FXFQ63MVE	FXLQ63MAVE	FXSQ40MVE
FXAQ63MAVE	FXDQ25PVET	FXFQ80MVE	FXMQ40MAVE	FXSQ50MVE
FXCQ20MVE	FXDQ32NAVE	FXFQ100MVE	FXMQ50MAVE	FXSQ63MVE
FXCQ25MVE	FXDQ32NVET	FXFQ125MVE	FXMQ63MAVE	FXSQ80MVE
FXCQ32MVE	FXDQ32PVE	FXHQ32MAVE	FXMQ80MAVE	FXSQ100MVE
FXCQ40MVE	FXDQ32PVET	FXHQ63MAVE	FXMQ100MAVE	FXSQ125MVE
FXCQ50MVE	FXDQ40NAVE	FXHQ100MAVE	FXMQ125MAVE	FXUQ71MAV1
FXCQ63MVE	FXDQ40NVET	FXKQ25MAVE	FXNQ20MAVE	FXUQ100MAV1
FXCQ80MVE	FXDQ50NAVE	FXKQ32MAVE	FXNQ25MAVE	FXUQ125MAV1
FXCQ125MVE	FXDQ50NVET	FXKQ40MAVE	FXNQ32MAVE	
FXDQ20NAVE	FXDQ63NAVE	FXKQ63MAVE	FXNQ40MAVE	
FXDQ20NVET	FXDQ63NVET	FXLQ20MAVE	FXNQ50MAVE	

Outdoor Units

RXMQ4PVE
RXMQ5PVE
RXMQ6PVE
RXYMQ4PVE
RXYMQ5PVE
RXYMQ6PVE

BS Units

BEVQ71MAVE
BEVQ100MAVE
BEVQ125MAVE

1. Troubleshooting by Remote Controller

1.1 The INSPECTION / TEST Button

The following modes can be selected by using the [Inspection/Test Operation] button on the remote control.

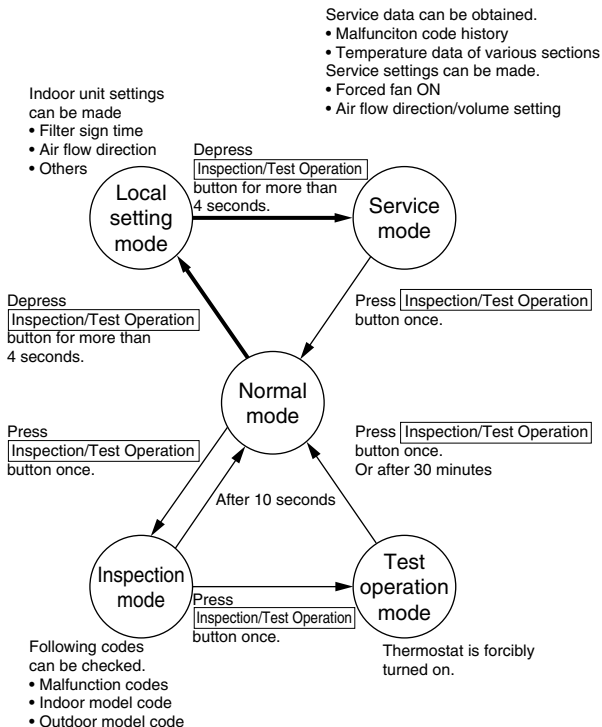

1.2 Self-diagnosis by Wired Remote Controller

Explanation

If operation stops due to malfunction, the remote controller's operation LED blinks, and malfunction code is displayed. (Even if stop operation is carried out, malfunction contents are displayed when the inspection mode is entered.) The malfunction code enables you to tell what kind of malfunction caused operation to stop. See page 26 for malfunction code and malfunction contents.

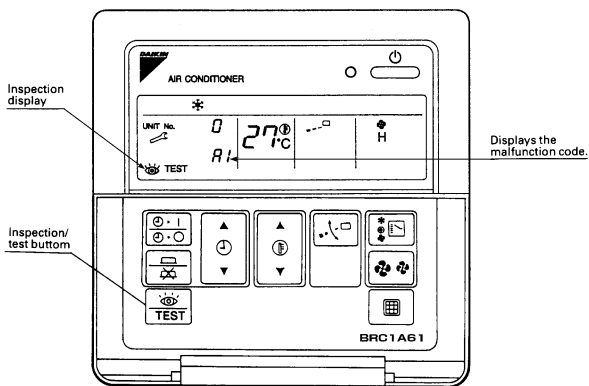

1.3 Self-diagnosis by Wireless Remote Controller

In the Case of BRC7C ~ Type

If equipment stops due to a malfunction, the operation indicating LED on the light reception section flashes. The malfunction code can be determined by following the procedure described below. (The malfunction code is displayed when an operation error has occurred. In normal condition, the malfunction code of the last problem is displayed.)

1. Press the INSPECTION/TEST button to select "Inspection."

The equipment enters the inspection mode. The "Unit" indication lights and the Unit No. display shows flashing "0" indication.

2. Set the Unit No.

Press the UP or DOWN button and change the Unit No. display until the buzzer (*1) is generated from the indoor unit.

*1 Number of beeps

3 short beeps : Conduct all of the following operations.

1 short beep : Conduct steps 3 and 4.

Continue the operation in step 4 until a buzzer remains ON. The continuous buzzer indicates that the malfunction code is confirmed.

Continuous beep : No abnormality.

3. Press the MODE selector button.

The left "0" (upper digit) indication of the malfunction code flashes.

4. Malfunction code upper digit diagnosis

Press the UP or DOWN button and change the malfunction code upper digit until the malfunction code matching buzzer (*2) is generated.

- The upper digit of the code changes as shown below when the UP and DOWN buttons are pressed.



⇒ "Advance" button ← "Backward" button

*2 Number of beeps

Continuous beep : Both upper and lower digits matched. (Malfunction code confirmed)

2 short beeps : Upper digit matched.

1 short beep : Lower digit matched.

5. Press the MODE selector button.
The right "0" (lower digit) indication of the malfunction code flashes.
6. Malfunction code lower digit diagnosis
Press the UP or DOWN button and change the malfunction code lower digit until the continuous malfunction code matching buzzer (*2) is generated.

- The lower digit of the code changes as shown below when the UP and DOWN buttons are pressed.

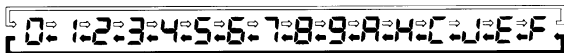

⇒ "Advance" button ← "Backward" button

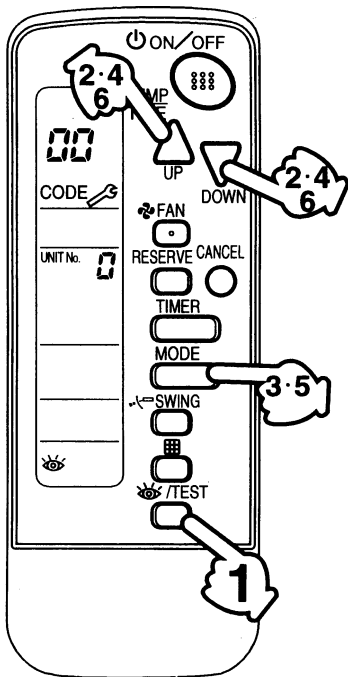

Normal status

Enters inspection mode from normal status when the INSPECTION/TEST button is pressed.

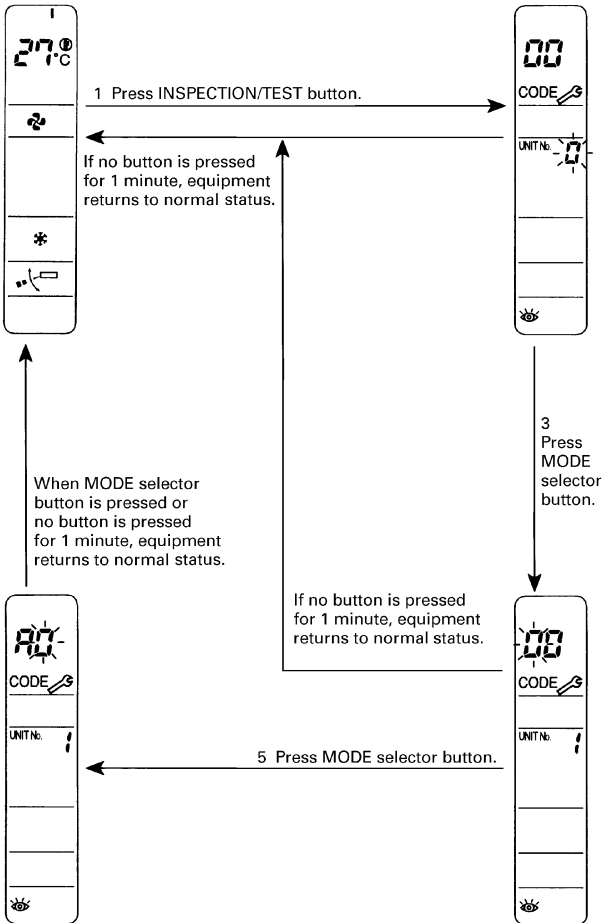

1.4 Operation of the Remote Controller's Inspection / Test Operation Button

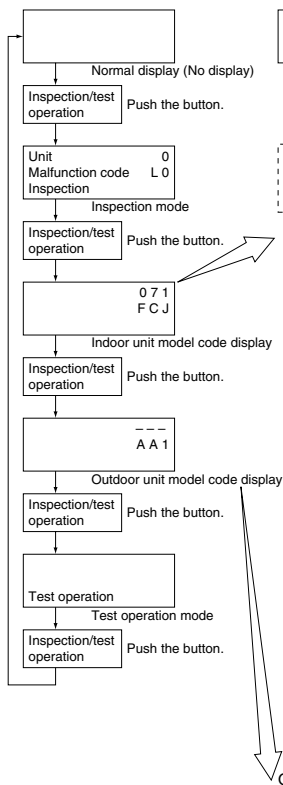

Unit 0
Malfunction code L 0
Inspection

Malfunction code blinks when a malfunction occurs.

0 7 1... Capacity code
F... Indoor unit system code
C... Indoor unit type code
J... Progression code

Example of capacity code display

Example model	Display
FXCQ25	028
FXFQ63	071

Indoor unit system code

Display	Product classification	System classification
1	VRV system	(VAV indoor unit)
2	VRV system	Outdoor air processing unit
F	VRV system	Standard indoor unit
H	VRV system	New ceiling suspended cassette

Indoor unit type code

Display	Type	Model
A	Wall mounted	FXAQ
C	Double flow	FXCQ
E	Corner	FXKQ
F	Multi flow	FXFQ
H	Ceiling suspended	FXHQ
J	Built-in	FXSQ
L	Floor standing	FXLQ
P	Concealed ceiling duct	FXMQ
L	Concealed floor standing type	FXNQ
6	Multi flow 600×600	FXZQ
3	Slim Ceiling mounted duc	FXDQ
5	New ceiling suspended cassette	FXUQ

Outdoor model code

Display	Type	Model
A A 1	VRV System Inverter K Series	RSXYP
A A 3	R-407C VRV PLUS Series	RXYP
A 9 2	VRV Heat Recovery Series	RSEYP
A A 5	High COP type R-407C L Series	RSXYP-L
A A A	VRV II	RXYQ-M
A A C	VRV II M/C	RXYQ-MA
A A E	VRV III Heat Pump Series	RXYQ-P
	Cooling Only Series	RXQ-P
A 8 E	VRV III-S	RXYSQ-P
A 9 E	VRV III Heat Recovery Series	REYQ-P

1.5 Remote Controller Service Mode

How to Enter the Service Mode

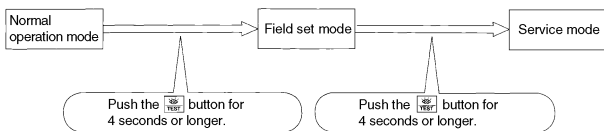

Service Mode Operation Method



1. Select the mode No.

Set the desired mode No. with the  button.
(For wireless remote controller, Mode 43 only can be set.)

2. Select the unit No. (For group control only)

Select the indoor unit No. to be set with the time mode



. (For wireless remote controller,   button.)

3. Make the settings required for each mode. (Modes 41, 44, 45)

In case of Mode 44, 45, push  button to be able to change setting before setting work. (LCD "code" blinks.)

For details, refer to the table in next page.



4. Define the setting contents. (Modes 44, 45)





Define by pushing the timer  button.

After defining, LCD "code" changes blinking to ON.

5. Return to the normal operation mode.

Push the  button one time.

Mode No	Function	Contents and operation method	Remote controller display example
40	Malfunction hysteresis display	<p>Display malfunction hysteresis.</p> <p>The history No. can be changed with the  button.</p>	<p>Unit 1 Malfunction code 40</p> <p>2-U4 Malfunction code</p> <p>History No: 1 - 9 1: Latest</p>
41	Display of sensor and address data	<p>Display various types of data.</p> <p>Select the data to be displayed with the  button. Sensor data</p> <p>0: Thermostat sensor in remote controller. 1: Suction 2: Liquid pipe 3: Gas pipe</p> <p>Address data 4: Indoor unit address 5: Outdoor unit address 6: BS unit address 7: Zone control address 8: Cool/heat group address 9: Demand / low noise address</p>	<p>Sensor data display</p> <p>Unit No. Sensor type</p> <p>1 1 41</p> <p>2 7</p> <p>Temperature °C</p> <p>Address display</p> <p>Unit No. Address type</p> <p>1 8 41</p> <p>1</p> <p>Address</p>
43	Forced fan ON	<p>Manually turn the fan ON by each unit. (When you want to search for the unit No.)</p> <p>By selecting the unit No. with the  button, you can turn the fan of each indoor unit on (forced ON) individually.</p>	<p>Unit 1</p> <p>43</p>

Mode No	Function	Contents and operation method	Remote controller display example
44	Individual setting	<p>Set the fan speed and air flow direction by each unit</p> <p>Select the unit No. with the time mode  button. Set the fan speed with the  button. Set the air flow direction with the  button.</p>	<p>Unit 1 Code</p> <p>44</p> <p>1 3</p> <p>Fan speed 1: Low 3: High</p> <p>Air flow direction P0 - P4</p>
45	Unit No. transfer	<p>Transfer unit No.</p> <p>Select the unit No. with the  button. Set the unit No. after transfer with the  button.</p>	<p>Present unit No.</p> <p>Unit 1 Code</p> <p>0 2</p> <p>45</p> <p>Unit No. after transfer</p>
46	This function is not used by VRV II R410A Heat Pump 50Hz.		
47			

1.6 Remote Controller Self-diagnosis Function

The remote controller switches are equipped with a self diagnosis function so that more appropriate maintenance can be carried out. If a malfunction occurs during operation, the operation lamp, malfunction code and display of malfunctioning unit No. let you know the contents and location of the malfunction.

When there is a stop due to malfunction, the contents of the malfunction given below can be diagnosed by a combination of operation lamp, INSPECTION display of the liquid crystal display and display of malfunction code. It also lets you know the unit No. during group control.

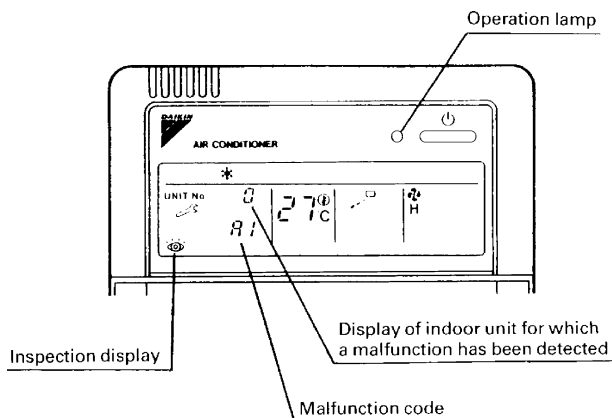

Malfunction code	Malfunction Contents	VRV II M(A) Series	VRV II-S M Series	VRV W II M Series	VRV III P Series 50Hz	VRV III P Series 60Hz	Reference page
A0	Error of External Protection Device	●	●	●	●	●	50
A1	PC Board Defect	●	●	●	●	●	51
A3	Malfunction of Drain Level Control System (S1L)	●	●	●	●	●	52
A6	Fan Motor (M1F) Lock, Overload	●	●		●	●	55
	Fan Motor (M1F) Lock, Overload			●			57
	Abnormal Indoor Fan Motor			●			59
A7	Malfunction of Swing Flap Motor (MA)	●	●	●	●	●	61
A9	Malfunction of Moving Part of Electronic Expansion Valve (20E)	●	●	●	●	●	64
AF	Drain Level above Limit	●	●	●	●	●	66
AJ	Malfunction of Capacity Determination Device	●	●	●	●	●	67
C4	Malfunction of Thermistor (R2T) for Heat Exchanger	●	●	●			69
	Malfunction of Thermistor (R2T) for Heat Exchanger				●	●	71
C5	Malfunction of Thermistor (R3T) for Gas Pipes	●	●	●			73
	Malfunction of Thermistor (R3T) for Gas Pipes				●	●	75
C9	Malfunction of Thermistor (R1T) for Suction Air	●	●	●			77
	Malfunction of Thermistor (R1T) for Suction Air				●	●	79
CA	Malfunction of Thermistor for Discharge Air		●				81
CJ	Malfunction of Thermostat sensor in Remote Controller	●	●	●	●	●	83
E1	PC Board Defect	●	●		●	●	86

Malfunction code	Malfunction Contents	VRV III P Series H/R	VRV III P Series C/O	VRV III-S P Series 50Hz	VRV III-S P Series 50/60Hz	Reference page
A0	Error of External Protection Device	●	●	●	●	50
A1	PC Board Defect	●	●	●	●	51
A3	Malfunction of Drain Level Control System (S1L)	●	●	●	●	52
A6	Fan Motor (M1F) Lock, Overload	●	●	●	●	55
	Fan Motor (M1F) Lock, Overload					57
	Abnormal Indoor Fan Motor					59
A7	Malfunction of Swing Flap Motor (MA)	●	●	●	●	61
A9	Malfunction of Moving Part of Electronic Expansion Valve (20E)	●	●	●	●	64
AF	Drain Level above Limit	●	●	●	●	66
AJ	Malfunction of Capacity Determination Device	●	●	●	●	67
C4	Malfunction of Thermistor (R2T) for Heat Exchanger			●	●	69
	Malfunction of Thermistor (R2T) for Heat Exchanger	●	●			71
C5	Malfunction of Thermistor (R3T) for Gas Pipes			●	●	73
	Malfunction of Thermistor (R3T) for Gas Pipes	●	●			75
C9	Malfunction of Thermistor (R1T) for Suction Air			●	●	77
	Malfunction of Thermistor (R1T) for Suction Air	●	●			79
CA	Malfunction of Thermistor for Discharge Air			●	●	81
CJ	Malfunction of Thermostat sensor in Remote Controller	●	●	●	●	83
E1	PC Board Defect	●	●	●	●	86

Malfunction code	Malfunction Contents	VRV II M(A) Series	VRV II-S M Series	VRV W II M Series	VRV III P Series 50Hz	VRV III P Series 60Hz	Reference page
E1	PC Board Defect			●			87
E3	Actuation of High Pressure Switch	●	●				89
	Actuation of High Pressure Switch						91
	Actuation of High Pressure Switch			●	●	●	94
E4	Actuation of Low Pressure Switch	●	●				97
	Actuation of Low Pressure Sensor						99
	Actuation of Low Pressure Sensor			●	●	●	102
E5	Compressor Motor Lock	●	●	●			105
	Inverter Compressor Motor Lock						107
	Inverter Compressor Motor Lock				●	●	110
E6	STD Compressor Motor Overcurrent/Lock	●				●	113
	STD Compressor Motor Overcurrent/Lock				●		115
E7	Malfunction of Outdoor Unit Fan Motor	●					118
	Malfunction of Outdoor Unit Fan Motor						121
	Malfunction of Outdoor Unit Fan Motor						125
	Malfunction of Outdoor Unit Fan Motor				●		127
	Malfunction of Outdoor Unit Fan Motor						131
E9	Malfunction of Moving Part of Electronic Expansion Valve (Y1E, Y2E)	●		●		●	134
	Malfunction of Moving Part of Electronic Expansion Valve (Y1E, Y2E, Y3E)						136
	Malfunction of Moving Part of Electronic Expansion Valve		●	●			138

Malfunction code	Malfunction Contents	VRV III P Series H/R	VRV III P Series C/O	VRV III-S P Series 50Hz	VRV III-S P Series 50/60Hz	Reference page
E1	PC Board Defect					87
E3	Actuation of High Pressure Switch					89
	Actuation of High Pressure Switch	●				91
	Actuation of High Pressure Switch			●	●	94
E4	Actuation of Low Pressure Switch					97
	Actuation of Low Pressure Sensor	●				99
	Actuation of Low Pressure Sensor			●	●	102
E5	Compressor Motor Lock			●	●	105
	Inverter Compressor Motor Lock	●				107
	Inverter Compressor Motor Lock		●			110
E6	STD Compressor Motor Overcurrent/Lock	●	●			113
	STD Compressor Motor Overcurrent/Lock					115
E7	Malfunction of Outdoor Unit Fan Motor					118
	Malfunction of Outdoor Unit Fan Motor	●	●			121
	Malfunction of Outdoor Unit Fan Motor				●	125
	Malfunction of Outdoor Unit Fan Motor					127
	Malfunction of Outdoor Unit Fan Motor			●		131
E9	Malfunction of Moving Part of Electronic Expansion Valve (Y1E, Y2E)				●	134
	Malfunction of Moving Part of Electronic Expansion Valve (Y1E, Y2E, Y3E)	●	●			136
	Malfunction of Moving Part of Electronic Expansion Valve					138

Malfunction code	Malfunction Contents	VRV II M(A) Series	VRV II-S M Series	VRV W II M Series	VRV III P Series 50Hz	VRV III P Series 60Hz	Reference page
E9	Malfunction of Moving Part of Electronic Expansion Valve (Y1E, Y2E)				●		140
F3	Abnormal Discharge Pipe Temperature	●	●			●	142
	Abnormal Discharge Pipe Temperature						144
	Abnormal Discharge Pipe Temperature			●			146
	Abnormal Discharge Pipe Temperature				●		148
F6	Refrigerant Overcharged	●					150
	Refrigerant Overcharged				●	●	151
	Refrigerant Overcharged			●			153
	Refrigerant Overcharged						155
H7	Abnormal Outdoor Fan Motor Signal	●			●	●	157
H9	Malfunction of Thermistor for Outdoor Air (R1T)	●	●		●	●	159
HJ	Malfunction of Water System			●			161
J2	Current Sensor Malfunction	●				●	164
	Current Sensor Malfunction						165
	Current Sensor Malfunction						167
	Current Sensor Malfunction				●		169
J3	Malfunction of Discharge Pipe Thermistor (R3, R31-33T)	●	●	●		●	171
	Malfunction of Discharge Pipe Thermistor (R3, R31-33T)				●		173
J4	Malfunction of Temperature Sensor for Heat Exchanger Gas (R2T)			●			175
J5	Malfunction of Thermistor (R2T) for Suction Pipe	●	●	●	●	●	177

Malfunction code	Malfunction Contents	VRV III P Series H/R	VRV III P Series C/O	VRV III-S P Series 50Hz	VRV III-S P Series 50/60Hz	Reference page
E9	Malfunction of Moving Part of Electronic Expansion Valve (Y1E, Y2E)			●		140
F3	Abnormal Discharge Pipe Temperature				●	142
	Abnormal Discharge Pipe Temperature	●	●			144
	Abnormal Discharge Pipe Temperature					146
	Abnormal Discharge Pipe Temperature			●		148
F6	Refrigerant Overcharged					150
	Refrigerant Overcharged	●	●	●		151
	Refrigerant Overcharged					153
	Refrigerant Overcharged				●	155
H7	Abnormal Outdoor Fan Motor Signal	●	●			157
H9	Malfunction of Thermistor for Outdoor Air (R1T)	●	●	●	●	159
HJ	Malfunction of Water System					161
J2	Current Sensor Malfunction					164
	Current Sensor Malfunction	●				165
	Current Sensor Malfunction		●			167
	Current Sensor Malfunction					169
J3	Malfunction of Discharge Pipe Thermistor (R3, R31-33T)	●	●	●	●	171
	Malfunction of Discharge Pipe Thermistor (R3, R31-33T)					173
J4	Malfunction of Temperature Sensor for Heat Exchanger Gas (R2T)	●				175
J5	Malfunction of Thermistor (R2T) for Suction Pipe	●	●	●	●	177

Malfunction code	Malfunction Contents	VRV II M(A) Series	VRV II-S M Series	VRV W II M Series	VRV III P Series 50Hz	VRV III P Series 60Hz	Reference page
J6	Malfunction of Thermistor (R4T) for Outdoor Unit Heat Exchanger	●	●		●	●	179
J7	Malfunction of Liquid Pipe Thermistor 1 (R6T), (R9T)			●	●	●	181
J8	Malfunction of Oil Equalizing Pipe Thermistor (R7T)	●					183
J9	Malfunction of Receiver Gas Pipe Thermistor (R5T)	●	●	●	●	●	185
JA	Malfunction of Discharge Pipe Pressure Sensor	●	●	●	●	●	187
	Malfunction of High Pressure Sensor						189
JC	Malfunction of Suction Pipe Pressure Sensor	●	●	●	●	●	192
	Malfunction of Low Pressure Sensor						194
L1	Defective Inverter PC Board						196
	Malfunction of PC Board						198
L4	Malfunction of Inverter Radiating Fin Temperature Rise	●	●	●			200
	Malfunction of Inverter Radiating Fin Temperature Rise				●	●	202
	Malfunction of Inverter Radiating Fin Temperature Rise						205
L5	Inverter Compressor Abnormal	●	●	●			207
	Momentary Overcurrent of Inverter Compressor						209
	Inverter Compressor Abnormal				●	●	211
L8	Inverter Current Abnormal	●	●	●			214
	Momentary Overcurrent of Inverter Compressor						216
	Inverter Current Abnormal				●	●	218
L9	Inverter Start up Error	●	●	●			221

Malfunction code	Malfunction Contents	VRV III P Series H/R	VRV III P Series C/O	VRV III-S P Series 50Hz	VRV III-S P Series 50/60Hz	Reference page
J6	Malfunction of Thermistor (R4T) for Outdoor Unit Heat Exchanger	●	●	●	●	179
J7	Malfunction of Liquid Pipe Thermistor 1 (R6T), (R9T)	●	●	●	●	181
J8	Malfunction of Oil Equalizing Pipe Thermistor (R7T)	●				183
J9	Malfunction of Receiver Gas Pipe Thermistor (R5T)	●	●	●	●	185
JA	Malfunction of Discharge Pipe Pressure Sensor			●	●	187
	Malfunction of High Pressure Sensor	●	●			189
JC	Malfunction of Suction Pipe Pressure Sensor			●	●	192
	Malfunction of Low Pressure Sensor	●	●			194
L1	Defective Inverter PC Board	●	●			196
	Malfunction of PC Board			●	●	198
L4	Malfunction of Inverter Radiating Fin Temperature Rise					200
	Malfunction of Inverter Radiating Fin Temperature Rise	●	●			202
	Malfunction of Inverter Radiating Fin Temperature Rise			●	●	205
L5	Inverter Compressor Abnormal			●	●	207
	Momentary Overcurrent of Inverter Compressor	●	●			209
	Inverter Compressor Abnormal					211
L8	Inverter Current Abnormal			●	●	214
	Momentary Overcurrent of Inverter Compressor	●	●			216
	Inverter Current Abnormal					218
L9	Inverter Start up Error			●	●	221

Malfunction code	Malfunction Contents	VRV II M(A) Series	VRV II-S M Series	VRV W II M Series	VRV III P Series 50Hz	VRV III P Series 60Hz	Reference page
L9	Inverter Compressor Starting Failure						223
	Inverter Start up Error				●	●	226
LC	Malfunction of Transmission Between Inverter and Control PC Board	●	●	●			229
	Malfunction of Transmission Between Inverter and Control PC Board				●	●	231
	Malfunction of Transmission Between Inverter and Control PC Board						235
	Malfunction of Transmission Between Inverter and Control PC Board						237
P1	Inverter Over-Ripple Protection	●		●	●	●	239
	High Voltage of Capacitor in Main Inverter Circuit						241
	High Voltage of Capacitor in Main Inverter Circuit						242
P4	Malfunction of Inverter Radiating Fin Temperature Rise Sensor	●	●	●			244
	Malfunction of Inverter Radiating Fin Temperature Rise Sensor				●	●	246
	Malfunction of Inverter Radiating Fin Temperature Rise Sensor						249
PJ	Faulty Field Setting after Replacing Main PC Board or Faulty Combination of PC Board				●	●	251
	Faulty Combination of Inverter and Fan Driver		●				253
U0	Low Pressure Drop due to Refrigerant Shortage or Electronic Expansion Valve Failure	●	●		●	●	255
	Gas Shortage Alert						257

Malfunction code	Malfunction Contents	VRV III P Series H/R	VRV III P Series C/O	VRV III-S P Series 50Hz	VRV III-S P Series 50/60Hz	Reference page
L9	Inverter Compressor Starting Failure	●	●			223
	Inverter Start up Error					226
LC	Malfunction of Transmission Between Inverter and Control PC Board					229
	Malfunction of Transmission Between Inverter and Control PC Board	●	●			231
	Malfunction of Transmission Between Inverter and Control PC Board				●	235
	Malfunction of Transmission Between Inverter and Control PC Board			●		237
P1	Inverter Over-Ripple Protection	●	●			239
	High Voltage of Capacitor in Main Inverter Circuit				●	241
	High Voltage of Capacitor in Main Inverter Circuit			●		242
P4	Malfunction of Inverter Radiating Fin Temperature Rise Sensor					244
	Malfunction of Inverter Radiating Fin Temperature Rise Sensor	●	●			246
	Malfunction of Inverter Radiating Fin Temperature Rise Sensor				●	249
PJ	Faulty Field Setting after Replacing Main PC Board or Faulty Combination of PC Board	●	●			251
	Faulty Combination of Inverter and Fan Driver					253
U0	Low Pressure Drop due to Refrigerant Shortage or Electronic Expansion Valve Failure				●	255
	Gas Shortage Alert	●	●			257

Malfunction code	Malfunction Contents	VRV II M(A) Series	VRV II-S M Series	VRV W II M Series	VRV III P Series 50Hz	VRV III P Series 60Hz	Reference page
U0	Low Pressure Drop due to Refrigerant Shortage or Electronic Expansion Valve Failure			●			260
	Low Pressure Drop due to Refrigerant Shortage or Electronic Expansion Valve Failure						263
U1	Reverse Phase, Open Phase	●		●	●	●	266
U2	Power Supply Insufficient or Instantaneous Failure	●		●			267
	Power Supply Insufficient or Instantaneous Failure				●	●	269
	Power Supply Insufficient or Instantaneous Failure		●				274
	Power Supply Insufficient or Instantaneous Failure						276
U3	Check Operation not Executed	●	●	●	●	●	278
U4	Malfunction of Transmission Between Indoor Units	●	●	●	●	●	279
	Malfunction of Transmission Between Indoor Units						282
	Malfunction of Transmission Between Indoor Units and Outdoor Units						286
U5	Malfunction of Transmission Between Remote Controller and Indoor Unit	●	●	●		●	289
	Malfunction of Transmission Between Remote Controller and Indoor Unit				●		291
U7	Malfunction of Transmission Between Outdoor Units	●		●		●	293
	Transmission Failure (Across Outdoor Units)						296
	Malfunction of Transmission Between Outdoor Units				●		304

Malfunction code	Malfunction Contents	VRV III P Series H/R	VRV III P Series C/O	VRV III-S P Series 50Hz	VRV III-S P Series 50/60Hz	Reference page
U0	Low Pressure Drop due to Refrigerant Shortage or Electronic Expansion Valve Failure					260
	Low Pressure Drop due to Refrigerant Shortage or Electronic Expansion Valve Failure			●		263
U1	Reverse Phase, Open Phase	●	●			266
U2	Power Supply Insufficient or Instantaneous Failure					267
	Power Supply Insufficient or Instantaneous Failure	●	●			269
	Power Supply Insufficient or Instantaneous Failure					274
	Power Supply Insufficient or Instantaneous Failure			●	●	276
U3	Check Operation not Executed	●	●	●	●	278
U4	Malfunction of Transmission Between Indoor Units				●	279
	Malfunction of Transmission Between Indoor Units	●	●			282
	Malfunction of Transmission Between Indoor Units and Outdoor Units			●		286
U5	Malfunction of Transmission Between Remote Controller and Indoor Unit	●	●	●	●	289
	Malfunction of Transmission Between Remote Controller and Indoor Unit					291
U7	Malfunction of Transmission Between Outdoor Units					293
	Transmission Failure (Across Outdoor Units)	●	●			296
	Malfunction of Transmission Between Outdoor Units					304

Malfunction code	Malfunction Contents	VRV II M(A) Series	VRV II-S M Series	VRV W II M Series	VRV III P Series 50Hz	VRV III P Series 60Hz	Reference page
U8	Malfunction of Transmission Between Master and Slave Remote Controllers	●	●	●	●	●	306
U9	Malfunction of Transmission Between Indoor and Outdoor Units in the Same System	●	●	●			308
	Malfunction of Transmission Between Indoor and Outdoor Units in the Same System					●	310
	Malfunction of Transmission Between Indoor and Outdoor Units in the Same System				●		312
UA	Excessive Number of Indoor Units	●	●	●			314
	Improper Combination of Indoor and Outdoor Units, Indoor Units and Remote Controller						316
	Improper Combination of Indoor and Outdoor Units, Indoor Units and Remote Controller				●	●	320
UC	Address Duplocation of Central Remote Controller	●	●	●			323
	Address Duplocation of Centralized Controller				●	●	324
UE	Malfunction of Transmission Between Central Remote Controller and Indoor Unit	●	●	●			325
	Malfunction of Transmission Between Centralized Controller and Indoor Unit				●	●	327
UF	Refrigerant System not Set, Incompatible Wiring/Piping	●	●	●	●	●	332
UH	Malfunction of System, Refrigerant System Address Undefined	●	●	●		●	334
	Malfunction of System, Refrigerant System Address Undefined				●		336

Malfunction code	Malfunction Contents	VRV III P Series H/R	VRV III P Series C/O	VRV III-S P Series 50Hz	VRV III-S P Series 50/60Hz	Reference page
U8	Malfunction of Transmission Between Master and Slave Remote Controllers	●	●	●	●	306
U9	Malfunction of Transmission Between Indoor and Outdoor Units in the Same System			●	●	308
	Malfunction of Transmission Between Indoor and Outdoor Units in the Same System	●	●			310
	Malfunction of Transmission Between Indoor and Outdoor Units in the Same System					312
UA	Excessive Number of Indoor Units			●	●	314
	Improper Combination of Indoor and Outdoor Units, Indoor Units and Remote Controller	●	●			316
	Improper Combination of Indoor and Outdoor Units, Indoor Units and Remote Controller					320
UC	Address Duplocation of Central Remote Controller			●	●	323
	Address Duplocation of Centralized Controller	●	●			324
UE	Malfunction of Transmission Between Central Remote Controller and Indoor Unit			●	●	325
	Malfunction of Transmission Between Centralized Controller and Indoor Unit	●	●			327
UF	Refrigerant System not Set, Incompatible Wiring/Piping	●	●	●	●	332
UH	Malfunction of System, Refrigerant System Address Undefined	●	●	●	●	334
	Malfunction of System, Refrigerant System Address Undefined					336

Malfunction code	Malfunction Contents	VRV II M(A) Series	VRV II-S M Series	VRV W II M Series	VRV III P Series 50Hz	VRV III P Series 60Hz	Reference page
UE	Malfunction of Transmission Between Central Remote Controller and Indoor Unit	●					338
M1	PC Board Defect	●	●	●			340
	PC Board Defect				●	●	341
M8	Malfunction of Transmission Between Optional Controllers for Centralized control	●	●	●			343
	Malfunction of Transmission Between Optional Controllers for Centralized control				●		345
	Malfunction of Transmission Between Optional Controllers for Centralized control					●	348
MA	Improper Combination of Optional Controllers for Centralized Control	●	●	●			351
	Improper Combination of Optional Controllers for Centralized Control				●	●	354
MC	Address Duplication, Improper Setting	●	●	●			357
	Address Duplication, Improper Setting				●	●	358

Malfunction code	Malfunction Contents	VRV III P Series H/R	VRV III P Series C/O	VRV III-S P Series 50Hz	VRV III-S P Series 50/60Hz	Reference page
UE	Malfunction of Transmission Between Central Remote Controller and Indoor Unit			●		338
M1	PC Board Defect			●	●	340
	PC Board Defect	●	●			341
M8	Malfunction of Transmission Between Optional Controllers for Centralized control			●	●	343
	Malfunction of Transmission Between Optional Controllers for Centralized control	●	●			345
	Malfunction of Transmission Between Optional Controllers for Centralized control					348
MA	Improper Combination of Optional Controllers for Centralized Control			●	●	351
	Improper Combination of Optional Controllers for Centralized Control	●	●			354
MC	Address Duplication, Improper Setting			●	●	357
	Address Duplication, Improper Setting	●	●			358

Malfunction code indication by outdoor unit PC board

To enter the monitor mode, push the MODE button (BS1) when in "Setting mode 1".

<Selection of setting item>

Push the SET button (BS2) and set the LED display to a setting item.

<Confirmation of malfunction 1>

Push the RETURN button (BS3) once to display "First digit" of malfunction code.

<Confirmation of malfunction 2>

Push the SET button (BS2) once to display "Second digit" of malfunction code.

<Confirmation of malfunction 3>

Push the SET button (BS2) once to display "master or slave1 or slave2" and "malfunction location".

Push the RETURN button (BS3) and switches to the initial status of "Monitor mode".

Detail description on next page.

* Push the MODE button (BS1) and returns to "Setting mode 1".

Contents of malfunction		Malfunction code
Abnormal discharge pressure	HPS activated	E3
Abnormal suction pressure	Abnormal Pe	E4
Compressor lock	Detection of INV compressor lock	E5
Activation of OC	Detection of STD1 compressor lock	E6
	Detection of STD2 compressor lock	
Over load, over current, abnormal lock of outdoor unit fan motor	Instantaneous over current of DC fan motor	E7
	Detection of DC fan motor lock	
Malfunction of electronic expansion valve	EV1	E9
	EV2	
	EV3	
Abnormal position signal of outdoor unit fan motor	Abnormal position signal of DC fan motor	H7
Faulty sensor of outdoor air temperature	Faulty Ta sensor	H9
Faulty sensor of heat storage unit		HC
Abnormality in water system of heat storage unit		HJ
Transmission error between heat storage unit and controller		HF
Abnormal discharge pipe temperature	Abnormal Td	F3
Abnormal heat exchanger temperature	Refrigerant over charge	F6
Faulty current sensor	Faulty CT1 sensor	J2
	Faulty CT2 sensor	
Faulty sensor of discharge pipe temperature	Faulty Tdi sensor	J3
	Faulty Tds1 sensor	
	Faulty Tds2 sensor	
Faulty sensor of suction pipe temperature	Faulty Ts sensor	J5
Faulty sensor of heat exchanger temperature	Faulty Tb sensor	J6
Faulty sensor of receiver temperature	Faulty TI sensor	J7
Faulty sensor of oil pressure equalizing pipe temperature	Faulty To sensor	J8

Contents of malfunction		Malfunction code
Faulty sensor of subcool heat exchanger temperature	Faulty Tsh sensor	J9
Faulty sensor of discharge pressure	Faulty Pc sensor	JA
Faulty sensor of suction pressure	Faulty Pe sensor	JC
Inverter radiation fin temperature rising	Over heating of inverter radiation fin temperature	L4
DC output over current	Inverter instantaneous over current	L5
Electronic thermal switch	Electronic thermal switch 1	L8
	Electronic thermal switch 2	
	Out-of-step	
	Speed down after startup	
	Lightening detection	
Stall prevention (Limit time)	Stall prevention (Current increasing)	L9
	Stall prevention (Faulty startup)	
	Abnormal wave form in startup	
	Out-of-step	
Transmission error between inverter and outdoor unit	Inverter transmission error	LC
Open phase/Power supply imbalance	Imbalance of inverter power supply voltage	P1
Faulty temperature sensor inside switch box	Faulty thermistor of inverter box	P3
Faulty temperature sensor of inverter radiation fin	Faulty thermistor of inverter fin	P4
Incorrect combination of inverter and fan driver	Incorrect combination of inverter and fan driver	PJ
Gas shortage	Gas shortage alarm	U0
Reverse phase	Reverse phase error	U1
Abnormal power supply voltage	Insufficient inverter voltage	U2
	Inverter open phase (phase T)	
	Charging error of capacitor in inverter main circuit	
No implementation of test-run		U3

Contents of malfunction		Malfunction code
Transmission error between indoor and outdoor unit	I/O transmission error	U4
Transmission error between outdoor units, transmission error between thermal storage units, duplication of IC address	O/O transmission error	U7
Transmission error of other system	Indoor unit system malfunction in other system or other unit of own system	U9
Erroneous on-site setting	Abnormal connection with excessive number of indoor units	UA
	Conflict of refrigerant type in indoor units	
Faulty system function	Incorrect wiring (Auto address error)	UH
Transmission error in accessory devices, conflict in wiring and piping, no setting for system	Malfunction of multi level converter, abnormality in conflict check	UJ
		UF

Malfunction code	Confirmation of malfunction 1							Confirmation of malfunction 2							Confirmation of malfunction 3						
	LED1	LED2	LED3	LED4	LED5	LED6	LED7	LED1	LED2	LED3	LED4	LED5	LED6	LED7	LED1	LED2	LED3	LED4	LED5	LED6	LED7
E3	○	●	○	●	●	○	○	○	○	●	●	●	○	○	○	○	○			●	●
E4					○	○	○	○	○	●	●	○	●	○	○	○	○			●	●
E5					○	○	○	○	○	●	●	○	●	○	○	○	○			●	●
E6					○	○	○	○	○	●	●	○	●	○	○	○	○			○	●
E7					○	○	○	○	○	●	●	○	○	○	○	○	○			○	○
E9					○	○	○	○	○	●	○	○	○	○	○	○	○			●	○
H7	○	●	○	●	○	○	○	○	○	○	○	○	○	○	○	○	○			○	○
H9					○	○	○	○	○	○	○	○	○	○	○	○	○			○	○
HC					○	○	○	○	○	○	○	○	○	○	○	○	○			○	○
HJ					○	○	○	○	○	○	○	○	○	○	○	○	○			○	○
HF					○	○	○	○	○	○	○	○	○	○	○	○	○			○	○
F3	○	●	○	●	○	○	○	○	○	○	○	○	○	○	○	○	○			○	○
F6					○	○	○	○	○	○	○	○	○	○	○	○	○			○	○

○ : ON
 ○ (with dot) : Blink
 ● : OFF

○ (with dot) : ON
 ○ (with dot) (with dot) : Blink
 ● (with dot) : OFF

○ (with dot) : Master
 ○ (with dot) (with dot) : Slave 1
 ● (with dot) : Slave 2

○ (with dot) : Malfunction code 1st digit display section
 ○ (with dot) (with dot) : Malfunction code 2st digit display section
 ○ (with dot) (with dot) (with dot) : Malfunction location

Malfunction code	Confirmation of malfunction 1							Confirmation of malfunction 2							Confirmation of malfunction 3							
	LED1	LED2	LED3	LED4	LED5	LED6	LED7	LED1	LED2	LED3	LED4	LED5	LED6	LED7	LED1	LED2	LED3	LED4	LED5	LED6	LED7	
J2	○	●	○	●	○	○	●	○	○	●	●	●	○	●	○	○	○			●	○	○
J3	○	○	○	●	○	○	○	○	○	○	○	○	○	○	○	○	○			○	○	○
J5	○	○	○	○	○	○	○	○	○	○	○	○	○	○	○	○	○			○	○	○
J6	○	○	○	○	○	○	○	○	○	○	○	○	○	○	○	○	○			○	○	○
J7	○	○	○	○	○	○	○	○	○	○	○	○	○	○	○	○	○			○	○	○
J8	○	○	○	○	○	○	○	○	○	○	○	○	○	○	○	○	○			○	○	○
J9	○	○	○	○	○	○	○	○	○	○	○	○	○	○	○	○	○			○	○	○
JA	○	○	○	○	○	○	○	○	○	○	○	○	○	○	○	○	○			○	○	○
JC	○	○	○	○	○	○	○	○	○	○	○	○	○	○	○	○	○			○	○	○
L4	○	●	○	●	○	○	○	○	○	○	○	○	○	○	○	○	○			○	○	○
L5	○	○	○	○	○	○	○	○	○	○	○	○	○	○	○	○	○			○	○	○
L8	○	○	○	○	○	○	○	○	○	○	○	○	○	○	○	○	○			○	○	○

○ : ON
 ○ : Blink
 ● : OFF

Malfunction code 1st digit display section

○ : ON
 ○ : Blink
 ● : OFF

Malfunction code 2st digit display section

Master
 Slave 1
 Slave 2

Malfunction location

Malfunction code	Confirmation of malfunction 1							Confirmation of malfunction 2							Confirmation of malfunction 3							
	LED1	LED2	LED3	LED4	LED5	LED6	LED7	LED1	LED2	LED3	LED4	LED5	LED6	LED7	LED1	LED2	LED3	LED4	LED5	LED6	LED7	
L8																						
L9	○	○	●	○	●	●	○	○	○	●	○	●	○	○	○	○	○			●		
LC	○	●	○	○	●	●	●	○	○	●	○	○	○	○	○	○	○			●		
P1	○							○	○	○	○	○	○	○	○	○	○			●		
P3	○							○	○	○	○	○	○	○	○	○	○			●		
P4	○							○	○	○	○	○	○	○	○	○	○			●		
PJ	○							○	○	○	○	○	○	○	○	○	○			●		
U0	○	●	○	○	●	●	○	○	○	○	○	○	○	○	○	○	○			●		
U1	○							○	○	○	○	○	○	○	○	○	○			●		
U2	○							○	○	○	○	○	○	○	○	○	○			●		

○ : ON
 ○ (with dot) : Blink
 ● : OFF

○ (with dot) : ON
 ○ (with dot) (with dot) : Blink
 ● (with dot) : OFF

○ (with dot) : Master
 ○ (with dot) (with dot) : Slave 1
 ● (with dot) (with dot) : Slave 2

Malfunction code 1st digit display section

Malfunction code 2st digit display section

Malfunction location

Malfunction code	Confirmation of malfunction 1							Confirmation of malfunction 2							Confirmation of malfunction 3							
	LED1	LED2	LED3	LED4	LED5	LED6	LED7	LED1	LED2	LED3	LED4	LED5	LED6	LED7	LED1	LED2	LED3	LED4	LED5	LED6	LED7	
U3								○	○	●	●	●	○	○	○	○	○			●	●	●
U4								○	○	●	●	○	●	○	○	○	○			●	●	●
U7								○	○	●	●	○	●	○	○	○	○			●	●	●
U9								○	○	●	●	○	●	○	○	○	○			●	●	●
UA								○	○	●	○	●	○	○	○	○	○			●	○	○
UH								○	○	●	○	●	○	○	○	○	○			●	○	○
UJ								○	○	●	○	●	○	○	○	○	○			●	○	○
UF								○	○	●	○	●	○	○	○	○	○			●	○	○

○	: ON
○	: Blink
●	: OFF

○	: ON
○	: Blink
●	: OFF

○	Master
○	Slave 1
○	Slave 2

Malfunction code 1st digit display section

Malfunction code 2st digit display section

Malfunction location

2. Troubleshooting by Indication on the Remote Controller

(1) Error of External Protection Device

Remote Controller Display

AO

Applicable Models

All indoor unit models

Supposed Causes

- Actuation of external protection device
- Improper field set
- Defect of indoor unit PC board

Troubleshooting



Caution

Be sure to turn off power switch before connect or disconnect connector, or parts damage may be occurred.

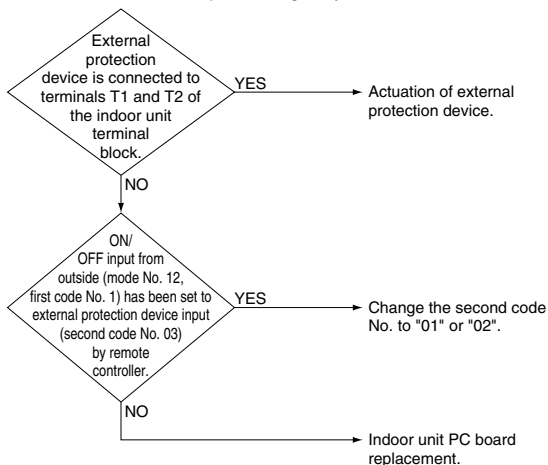

(2) PC Board Defect

Remote Controller Display

A1

Applicable Models

All indoor unit models

Method of Malfunction Detection

Check data from E²PROM.

Malfunction Decision Conditions

When data could not be correctly received from the E²PROM

E²PROM : Type of nonvolatile memory. Maintains memory contents even when the power supply is turned off.

A0

A1

Supposed Causes

- Defect of indoor unit PC board

Troubleshooting

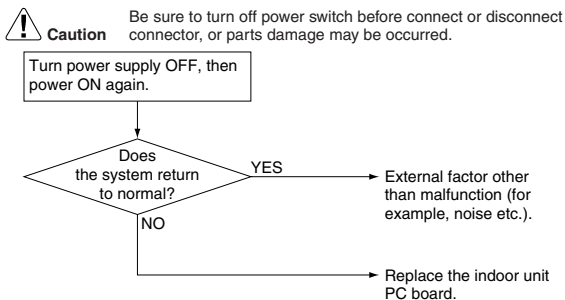

(3) Malfunction of Drain Level Control System (S1L)

Remote Controller Display

A3

Applicable Models

All indoor unit models

Method of Malfunction Detection

By float switch OFF detection

Malfunction Decision Conditions

When rise of water level is not a condition and the float switch goes OFF.

Supposed Causes

- 220~240V power supply is not provided
- Defect of float switch or short circuit connector
- Defect of drain pump
- Drain clogging, upward slope, etc.
- Defect of indoor unit PC board
- Loose connection of connector

Troubleshooting



Caution

Be sure to turn off power switch before connect or disconnect connector, or parts damage may be occurred.

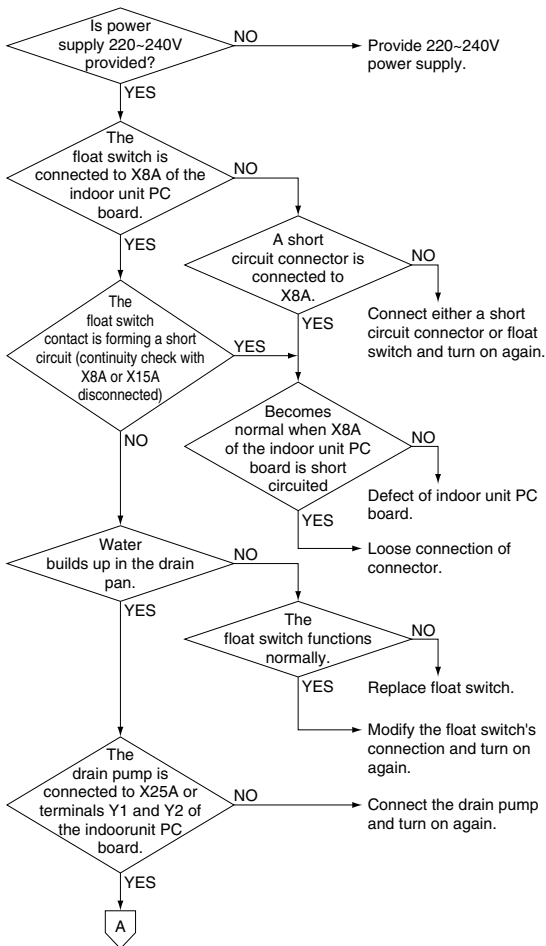

A3

**Caution**

Be sure to turn off power switch before connect or disconnect connector, or parts damage may be occurred.

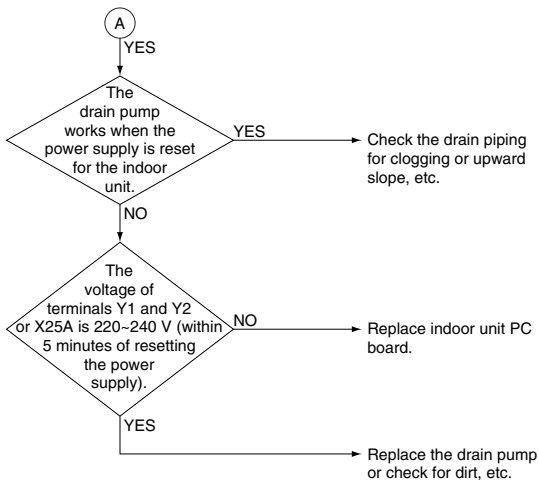

(4) Fan Motor (M1F) Lock, Overload

Remote Controller Display

A6

Applicable Models

All indoor unit models
(Except WII M Series)

Method of Malfunction Detection

Detection by failure of signal for detecting number of turns to come from the fan motor

Malfunction Decision Conditions

When number of turns can't be detected even when output voltage to the fan is maximum

Supposed Causes

- Fan motor lock
- Disconnected or faulty wiring between fan motor and PC board

A3

A6

Troubleshooting



Caution

Be sure to turn off power switch before connect or disconnect connector, or parts damage may be occurred.

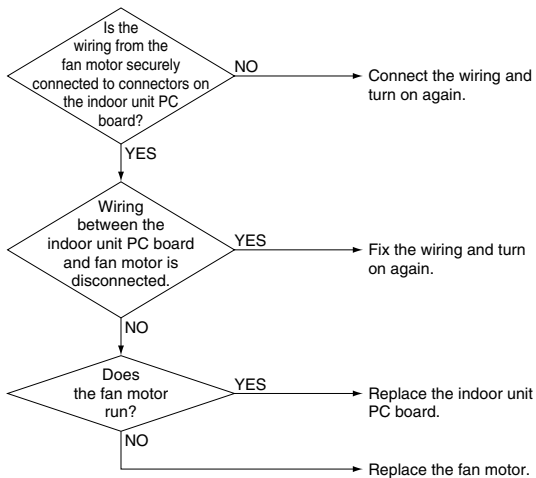

Remote Controller Display

A6

Applicable Models

VRV VII Series (FXDQ, FXHQ)

Method of Malfunction Detection

Detection by failure of signal for detecting number of turns to come from the fan motor

Malfunction Decision Conditions

When number of turns can't be detected even when output voltage to the fan is maximum

Supposed Causes

- Fan motor lock
- Disconnected or faulty contact between fan motor and PC board

A6

Troubleshooting



Caution

Be sure to turn off power switch before connect or disconnect connector, or parts damage may be occurred.

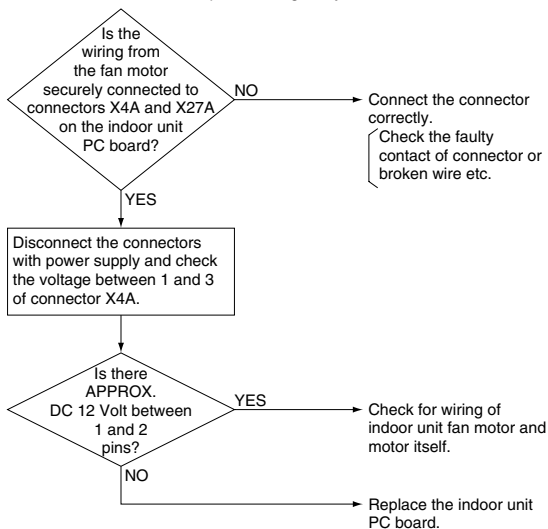

Remote Controller Display

A6

Applicable Models

VRV WII Series (FXFQ, FXAQ)

Method of Malfunction Detection

Detect abnormal fan rotation with the signal from the fan motor

Malfunction Decision Conditions

When fan rotation does not increase

Supposed Causes

- Disconnected/short-circuited fan motor harnesses or disconnected connectors
- Faulty fan motor
(Disconnection and insulation failure)
- Abnormal signal from the fan motor
(Circuit breakdown)
- Faulty PC board
- Instantaneous disturbance of power supply voltage
- Fan motor lock
(Caused by the motor or external factors)
- Fan does not rotate because foreign particles are trapped in it.
- Disconnected connector between PC boards A1P and A2P

A6

Troubleshooting



Caution

Be sure to turn off power switch before connect or disconnect connector, or parts damage may be occurred.

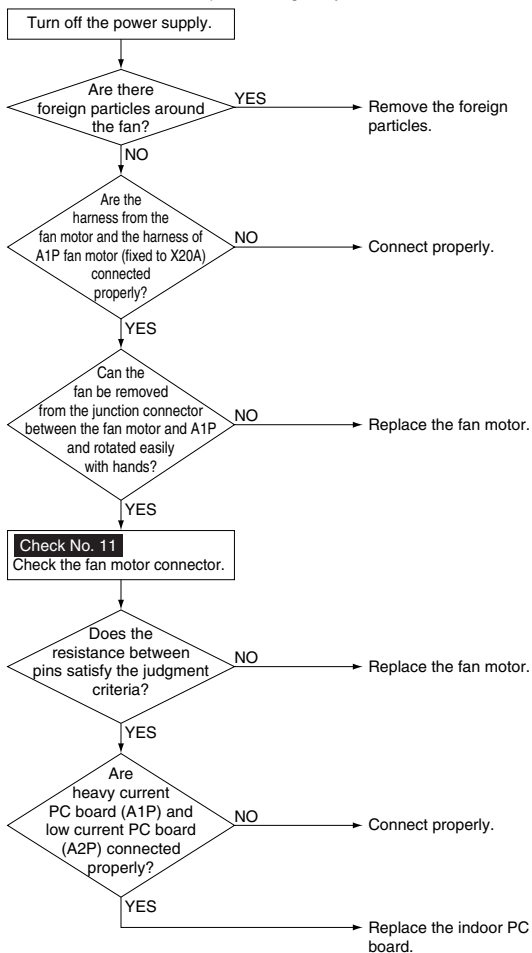

Refer to Check No. 11 on page 385.

(5) Malfunction of Swing Flap Motor (MA)

Remote Controller Display

A7

Applicable Models

All indoor unit models

Method of Malfunction Detection

Utilizes ON/OFF of the limit switch when the motor turns.

Malfunction Decision Conditions

When ON/OFF of the microswitch for positioning cannot be reversed even though the swing flap motor is energized for a specified amount of time (about 30 seconds).

A6

A7

Supposed Causes

- Defect of swing motor
- Defect of connection cable (power supply and limit switch)
- Defect of air flow direction adjusting flap-cam
- Defect of indoor unit PC board

Troubleshooting



Caution

Be sure to turn off power switch before connect or disconnect connector, or parts damage may be occurred.

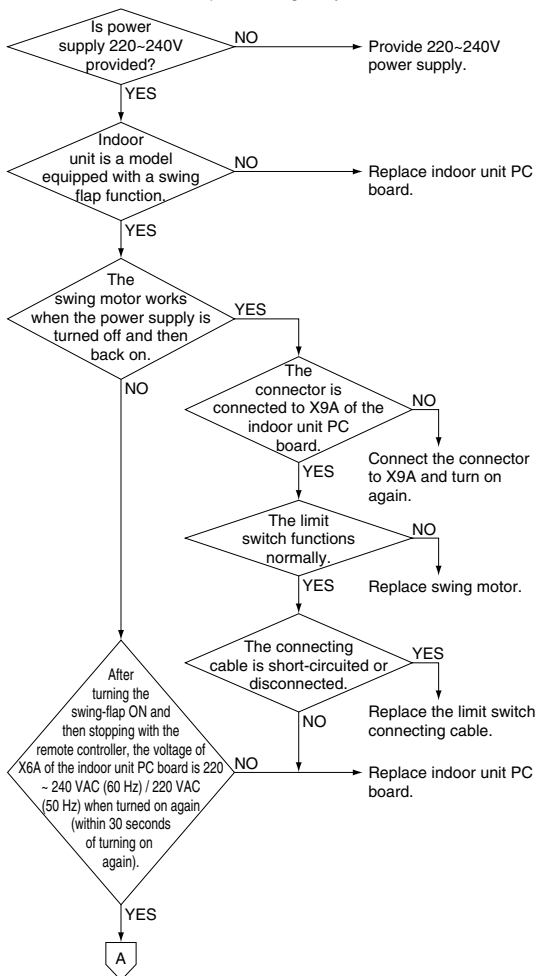

**Caution**

Be sure to turn off power switch before connect or disconnect connector, or parts damage may be occurred.

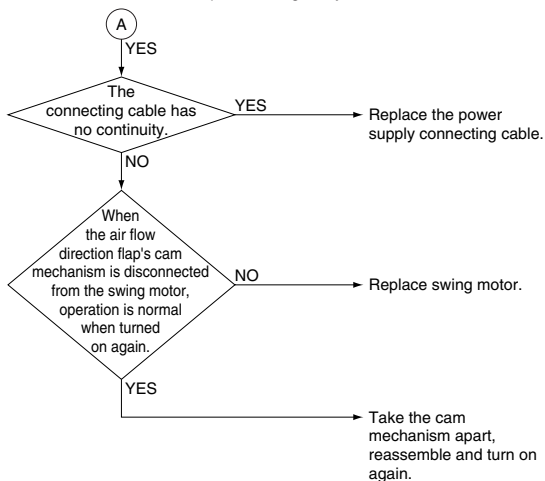
**A7**

(6) Malfunction of Moving Part of Electronic Expansion Valve (20E)

Remote Controller Display

89

Applicable Models

All indoor unit models

Supposed Causes

- Malfunction of moving part of electronic expansion valve
- Defect of indoor unit PC board
- Defect of connecting cable

Troubleshooting



Caution

Be sure to turn off power switch before connect or disconnect connector, or parts damage may be occurred.

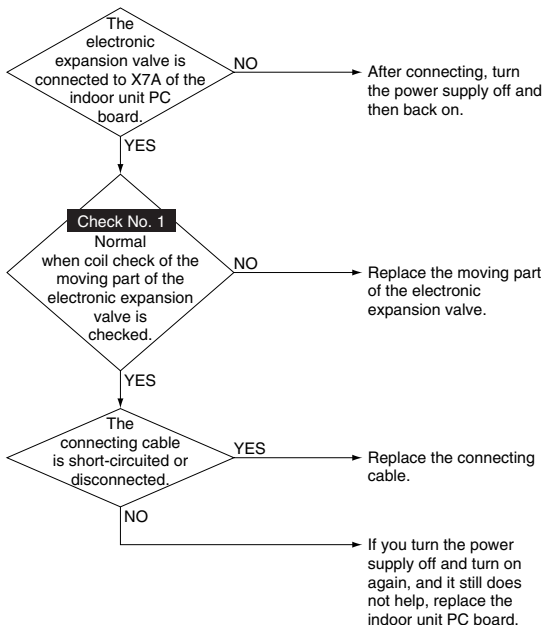

A9



Refer to Check No. 1 on page 360.

(7) Drain Level above Limit

Remote Controller Display

AF

Applicable Models

FXCQ, FXFQ, FXZQ, FXSQ, FXKQ, FXMQ, FXDQ, FXMQ-MF, FXUQ

Method of Malfunction Detection

Water leakage is detected based on float switch ON/OFF operation while the compressor is in non-operation.

Malfunction Decision Conditions

When the float switch changes from ON to OFF while the compressor is in non-operation.

Supposed Causes

- Humidifier unit (optional accessory) leaking
- Defect of drain pipe (upward slope, etc.)
- Defect of indoor unit PC board

Troubleshooting



Caution

Be sure to turn off power switch before connect or disconnect connector, or parts damage may be occurred.

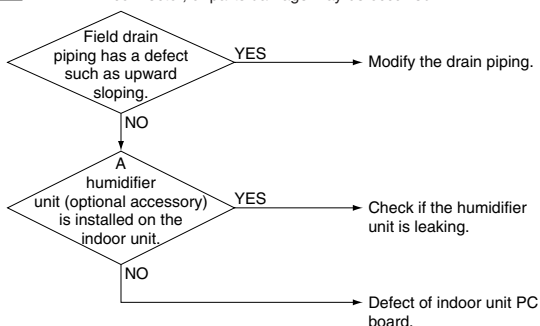

(8) Malfunction of Capacity Determination Device

Remote Controller Display

AJ

Applicable Models

All indoor unit models

Method of Malfunction Detection

Capacity is determined according to resistance of the capacity setting adaptor and the memory inside the IC memory on the indoor unit PC board, and whether the value is normal or abnormal is determined.

Malfunction Decision Conditions

Operation and:

1. When the capacity code is not contained in the PC board's memory, and the capacity setting adaptor is not connected.
2. When a capacity that doesn't exist for that unit is set.

Supposed Causes

- You have forgotten to install the capacity setting adaptor.
- Defect of indoor unit PC board

AF

AJ

Troubleshooting



Caution

Be sure to turn off power switch before connect or disconnect connector, or parts damage may be occurred.

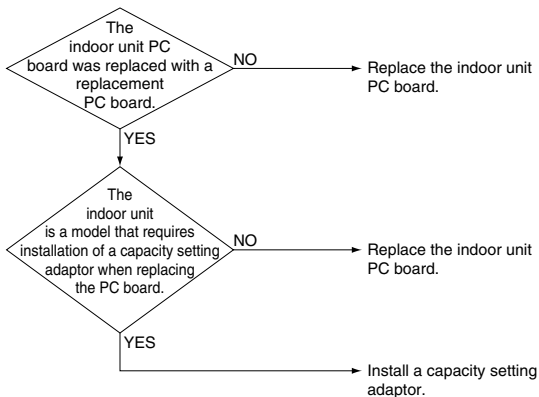

(9) Malfunction of Thermistor (R2T) for Heat Exchanger

Remote Controller Display

C4

Applicable Models

VRV II, II-S, WII and III-S Series

Method of Malfunction Detection

Malfunction detection is carried out by temperature detected by heat exchanger thermistor.

Malfunction Decision Conditions

When the heat exchanger thermistor becomes disconnected or shorted while the unit is running.

Supposed Causes

- Defect of thermistor (R2T) for liquid pipe
- Defect of indoor unit PC board

AJ

C4

Troubleshooting



Caution

Be sure to turn off power switch before connect or disconnect connector, or parts damage may be occurred.

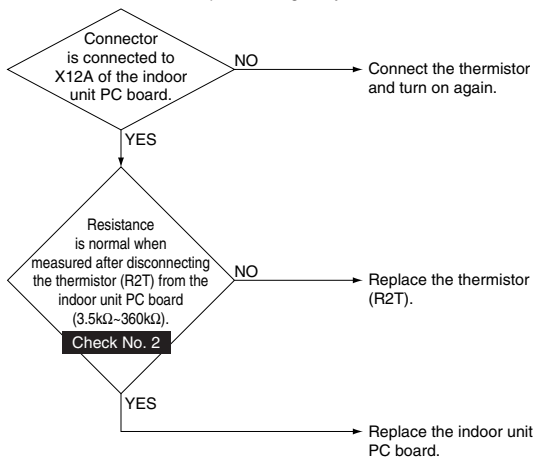

Refer to Check No. 2 on page 361.

Remote Controller Display

C4

Applicable Models

VRV III Series

Method of Malfunction Detection

Malfunction detection is carried out by temperature detected by heat exchanger thermistor.

Malfunction Decision Conditions

When the heat exchanger thermistor becomes disconnected or shorted while the unit is running.

Supposed Causes

- Defect of thermistor (R2T) for liquid pipe
- Defect of indoor unit PC board

C4

Troubleshooting



Caution

Be sure to turn off power switch before connect or disconnect connector, or parts damage may be occurred.

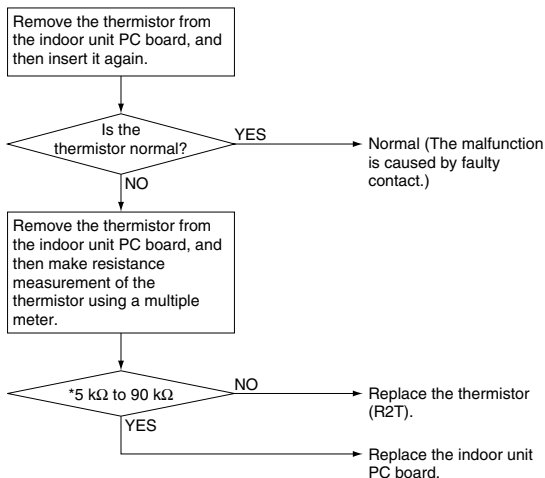

Refer to Check No. 2 on page 361.

(10) Malfunction of Thermistor (R3T) for Gas Pipes

Remote Controller Display

C5

Applicable Models

VRV II, II-S, WII and III-S Series

Method of Malfunction Detection

Malfunction detection is carried out by temperature detected by gas pipe thermistor.

Malfunction Decision Conditions

When the gas pipe thermistor becomes disconnected or shorted while the unit is running.

Supposed Causes

- Defect of indoor unit thermistor (R3T) for gas pipe
- Defect of indoor unit PC board

C4

C5

Troubleshooting



Caution

Be sure to turn off power switch before connect or disconnect connector, or parts damage may be occurred.

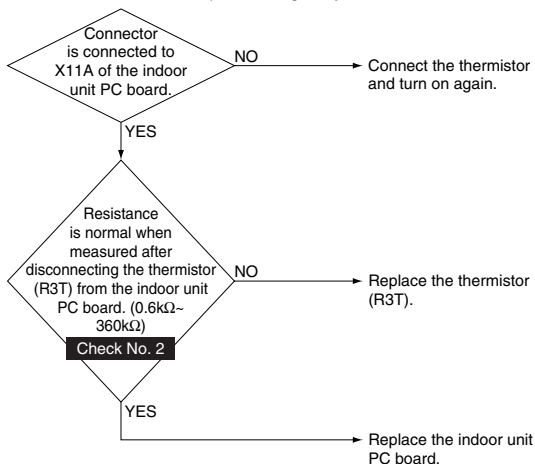

Refer to Check No. 2 on page 361.

Remote Controller Display

C5

Applicable Models

VRV III Series

Method of Malfunction Detection

Malfunction detection is carried out by temperature detected by gas pipe thermistor.

Malfunction Decision Conditions

When the gas pipe thermistor becomes disconnected or shorted while the unit is running.

Supposed Causes

- Defect of indoor unit thermistor (R3T) for gas pipe
- Defect of indoor unit PC board

C5

Troubleshooting



Caution

Be sure to turn off power switch before connect or disconnect connector, or parts damage may be occurred.

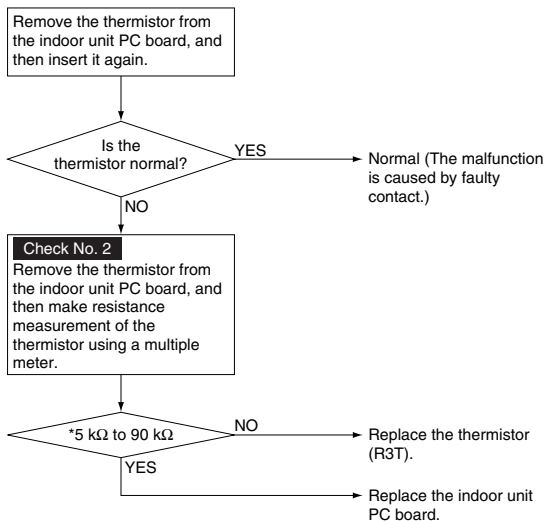

Refer to Check No. 2 on page 361.

(11) Malfunction of Thermistor (R1T) for Suction Air

Remote Controller Display

C9

Applicable Models

VRV II, II-S, WII and III-S Series

Method of Malfunction Detection

Malfunction detection is carried out by temperature detected by suction air temperature thermistor.

Malfunction Decision Conditions

When the suction air temperature thermistor becomes disconnected or shorted while the unit is running.

Supposed Causes

- Defect of indoor unit thermistor (R1T) for air inlet
- Defect of indoor unit PC board

C5

C9

Troubleshooting



Caution

Be sure to turn off power switch before connect or disconnect connector, or parts damage may be occurred.

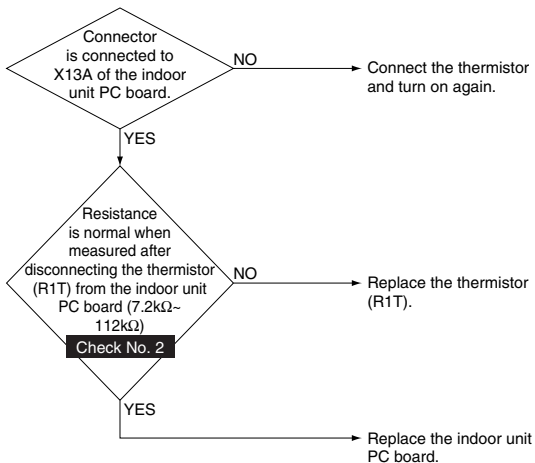

Refer to Check No. 2 on page 361.

Remote Controller Display

C9

Applicable Models

VRV III Series

Method of Malfunction Detection

Malfunction detection is carried out by temperature detected by suction air temperature thermistor.

Malfunction Decision Conditions

When the suction air temperature thermistor becomes disconnected or shorted while the unit is running.

Supposed Causes

- Defect of indoor unit thermistor (R1T) for air inlet
- Defect of indoor unit PC board

C9

Troubleshooting



Caution

Be sure to turn off power switch before connect or disconnect connector, or parts damage may be occurred.

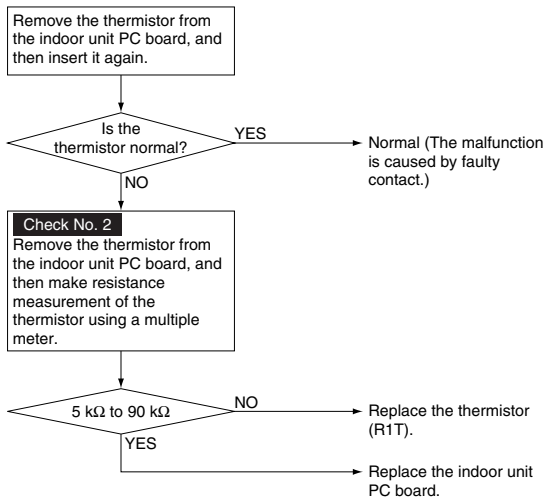

Refer to Check No. 2 on page 361.

(12) Malfunction of Thermistor for Air Outlet

Remote Controller Display

CA

Applicable Models

VRV III-S Series

Method of Malfunction Detection

Malfunction detection is carried out by temperature detected by discharge air thermistor.

Malfunction Decision Conditions

When the discharge air thermistor becomes disconnected or shorted while the unit is running.

Supposed Causes

- Defect of indoor unit thermistor for air outlet
- Defect of indoor unit PC board

C9

CA

Troubleshooting



Caution

Be sure to turn off power switch before connect or disconnect connector, or parts damage may be occurred.

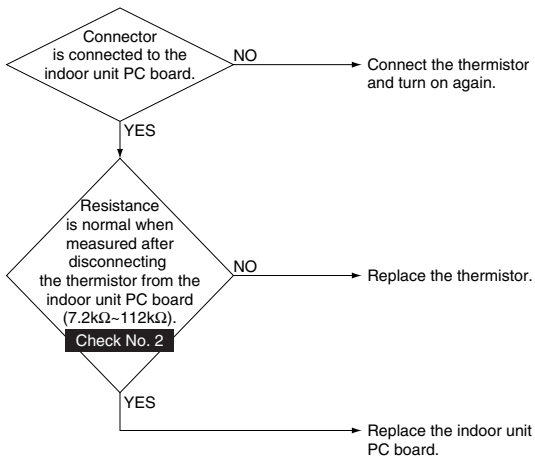

Refer to Check No. 2 on page 361.

(13) Malfunction of Thermostat Sensor in Remote Controller

Remote Controller Display



Applicable Models

All indoor unit models

Method of Malfunction Detection

Malfunction detection is carried out by temperature detected by remote controller air temperature thermistor.
(Note1)

Malfunction Decision Conditions

When the remote controller air temperature thermistor becomes disconnected or shorted while the unit is running.

CA

CJ

Supposed Causes

- Defect of remote controller thermistor
- Defect of remote controller PC board

Troubleshooting



Caution

Be sure to turn off power switch before connect or disconnect connector, or parts damage may be occurred.

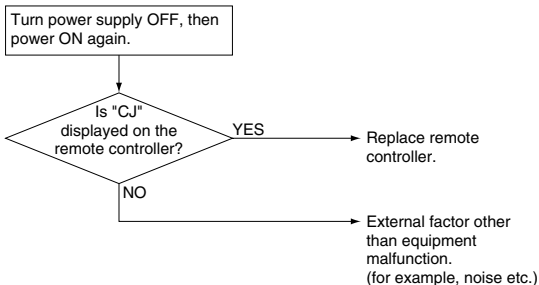

Note:

In case of remote controller thermistor malfunction, unit is still operable by suction air thermistor on indoor unit.

Remote Controller Display



Applicable Models

VRV II-S and III-S Series

Method of Malfunction Detection

Malfunction detection is carried out by temperature detected by discharge air temperature thermistor.

Malfunction Decision Conditions

When the discharge air temperature thermistor becomes disconnected or shorted while the unit is running.

Supposed Causes

- Defect of indoor unit thermistor for air outlet
- Defect of indoor unit PC board

CJ

Troubleshooting



Caution

Be sure to turn off power switch before connect or disconnect connector, or parts damage may be occurred.

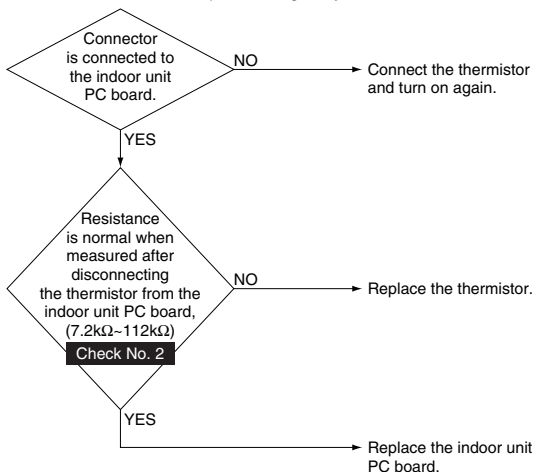

Refer to Check No. 2 on page 361.

(14) PC Board Defect

Remote Controller Display

E1

Applicable Models

except VRV WII Series

Method of Malfunction Detection

Check data from E²PROM

Malfunction Decision Conditions

When data could not be correctly received from the E²PROM

E²PROM : Type of nonvolatile memory. Maintains memory contents even when the power supply is turned off.

Supposed Causes

- Defect of outdoor unit PC board (A1P)

Troubleshooting



Caution

Be sure to turn off power switch before connect or disconnect connector, or parts damage may be occurred.

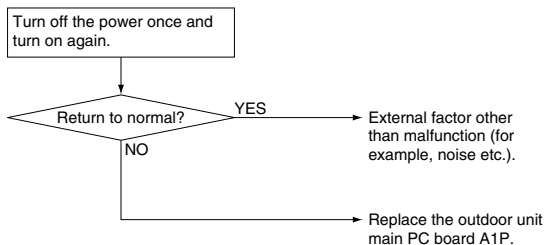

Remote Controller Display

E1

Applicable Models

VRV VII Series

Method of Malfunction Detection

Detect abnormalities by checking communication status of the hard part between the indoor unit and outside unit.

Malfunction Decision Conditions

When communication status of the hard part between the indoor unit and heat source unit is abnormal

Supposed Causes

- Faulty main PC board
- Faulty communication part (photo coupler) on the main PC board

E1

Troubleshooting



Caution

Be sure to turn off power switch before connect or disconnect connector, or parts damage may be occurred.

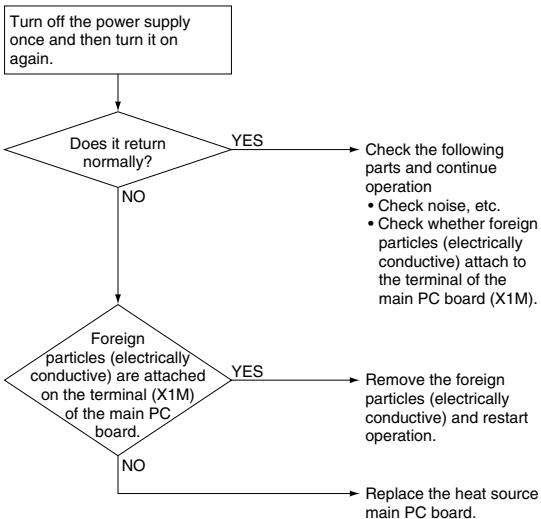

(15) Actuation of High Pressure Switch

Remote Controller Display

E3

Applicable Models

VRV II and II-S Series

Method of Malfunction Detection

Abnormality is detected when the contact of the high pressure protection switch opens.

Malfunction Decision Conditions

Error is generated when the HPS activation count reaches the number specific to the operation mode.

Supposed Causes

- Actuation of outdoor unit high pressure switch
- Defect of High pressure switch
- Defect of outdoor unit PC board
- Instantaneous power failure
- Faulty high pressure sensor

E1

E3

Troubleshooting



Caution

Be sure to turn off power switch before connect or disconnect connector, or parts damage may be occurred.

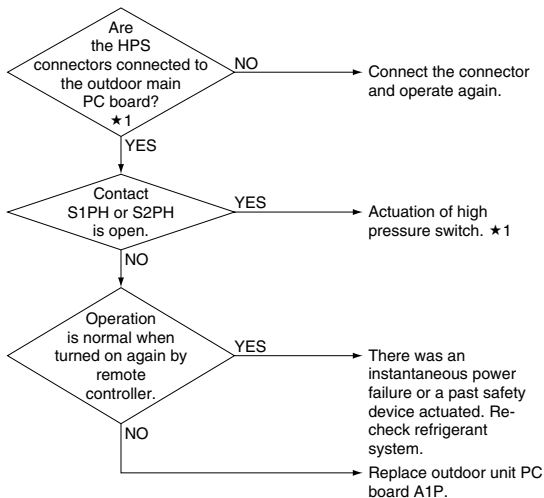

★ 1: Actuation of high pressure switch (HPS)

- The outdoor unit PC board's connector is disconnected.
- Is the outdoor unit heat exchanger dirty?
- Defect of outdoor fan
- Is the refrigerant over-charged?
- Faulty high pressure sensor

Remote Controller Display

E3

Applicable Models

VRV III H/R Series

Method of Malfunction Detection

Abnormality is detected when the contact of the high pressure protection switch opens.

Malfunction Decision Conditions

Error is generated when the HPS activation count reaches the number specific to the operation mode.
(Reference) Operating pressure of high pressure switch

Operating pressure: 4.0MPa

Reset pressure: 2.85MPa

E3

Supposed Causes

- Actuation of outdoor unit high pressure switch
- Defect of High pressure switch
- Defect of outdoor unit main PC board (A1P)
- Instantaneous power failure
- Faulty high pressure sensor

Troubleshooting



Caution

Be sure to turn off power switch before connect or disconnect connector, or parts damage may be occurred.

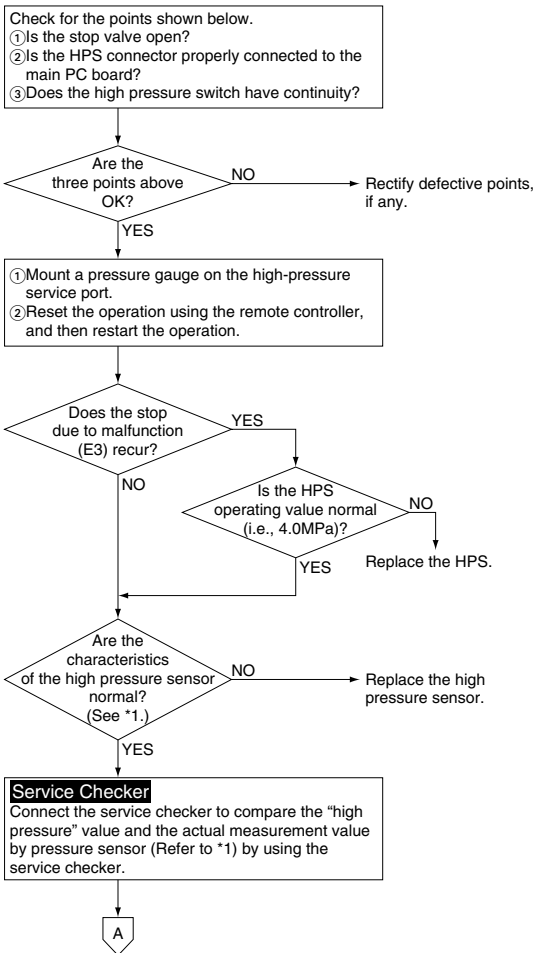

**Caution**

Be sure to turn off power switch before connect or disconnect connector, or parts damage may be occurred.

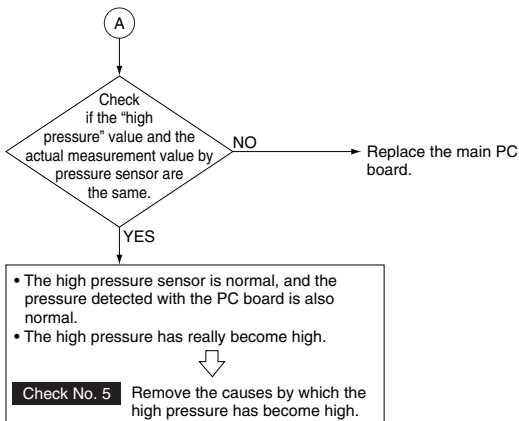
**E3**

- *1: Make a comparison between the voltage of the pressure sensor and that read by the pressure gauge. (As to the voltage of the pressure sensor, make measurement of voltage at the connector, and then convert it to pressure according to **Check No.4** on page 366.)
- *2. **Check No.3** Measure the voltage of the pressure sensor.



Refer to Check No. 3~5 on page 365~367.

Remote Controller Display



Applicable Models

VRV III, III-S and VII Series

Method of Malfunction Detection

Detect conductive property of the high pressure switch with the protector circuit.

Malfunction Decision Conditions

When the protector circuit is partially opened

(For reference) Working pressure for the high pressure switch

Working pressure: 4.0 MPa

Return pressure: 2.85 MPa

Supposed Causes

- High pressure switch operation
- Faulty high pressure switch
- Faulty main PC board
- Temporal power failure
- Faulty high pressure sensor
- Insufficient heat source water
- Dirty water heat exchanger

Troubleshooting



Caution

Be sure to turn off power switch before connect or disconnect connector, or parts damage may be occurred.

Check the following items:

- ① Is the stop valve open?
- ② Is the connector for HPS properly connected to the main PC board?
- ③ Is the high pressure switch electrically conductive?

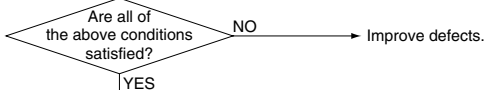

- Set up a pressure gauge in the high pressure service port.
- Connect the Service Checker.
- Restart operation after resetting operation with a remote controller.

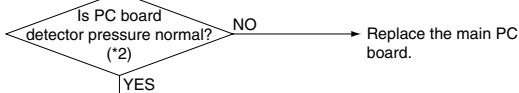
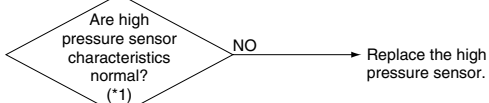
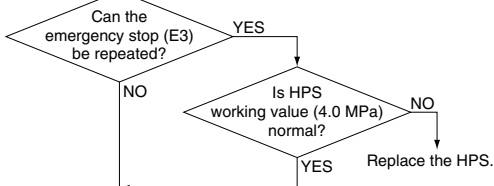

- The high pressure sensor is normal and the main PC board pressure detection is also normal.
- In fact, high pressure is rising.



Check No. 5 : Eliminate the causes of high pressure rise.

E3

- *1 : Make a comparison between the voltage of the pressure sensor and that read by the pressure gauge. (As to the voltage of the pressure sensor, make measurement of voltage at the connector, and then convert it to pressure according to **Check No.4** .)
- *2 : Compare “high pressure” checked with the Service Checker with pressure sensor voltage measurements (refer to **Check No.4**).
- *3. **Check No.3** Measure the voltage of the pressure sensor.



Refer to Check No. 3~5 on page 365~367.

(16) Actuation of Low Pressure Sensor

Remote Controller Display

E4

Applicable Models

VRV II and II-S Series

Malfunction Decision Conditions

Error is generated when the low pressure is dropped under specific pressure.

Supposed Causes

- Abnormal drop of low pressure (Lower than 0.07MPa)
- Defect of low pressure sensor
- Defect of outdoor unit PC board
- Stop valve is not opened.

E3

E4

Troubleshooting



Caution

Be sure to turn off power switch before connect or disconnect connector, or parts damage may be occurred.

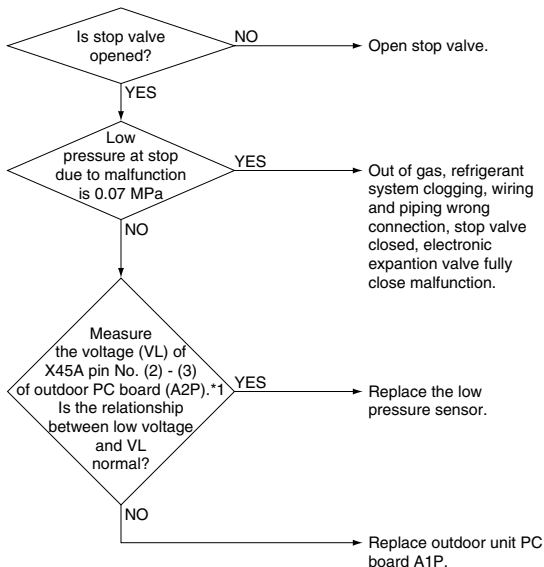

- *1. **Check No.3** Measure the voltage of the pressure sensor.



Refer to Check No. 3, 4 on page 365, 366.

Remote Controller Display

E4

Applicable Models

VRV III H/R Series

Method of Malfunction Detection

Abnormality is detected by the pressure value with the low pressure sensor.

Malfunction Decision Conditions

Error is generated when the low pressure is dropped under compressor operation.

Operating pressure: 0.07MPa

Supposed Causes

- Abnormal drop of low pressure (Lower than 0.07MPa)
- Defect of low pressure sensor
- Defect of outdoor unit PC board
- Stop valve is not opened.

E4

Troubleshooting



Caution

Be sure to turn off power switch before connect or disconnect connector, or parts damage may be occurred.

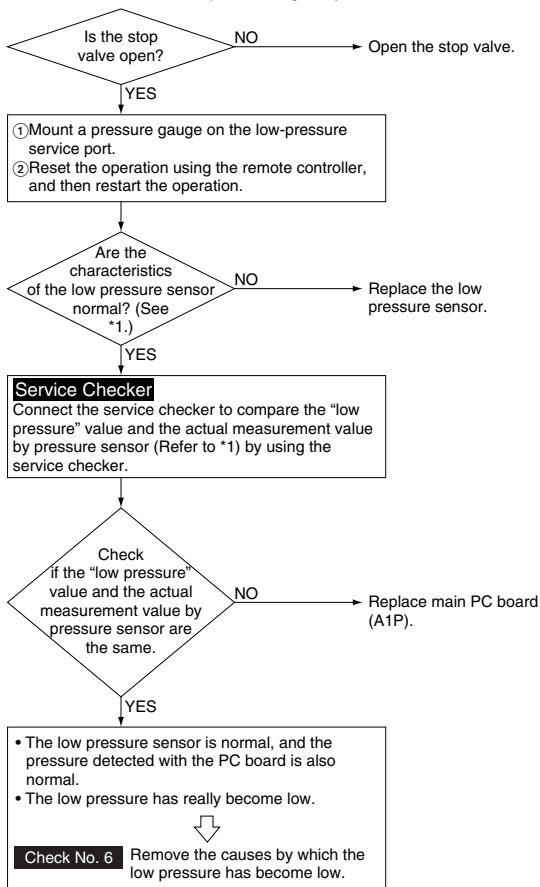

- *1 : Make a comparison between the voltage of the pressure sensor and that read by the pressure gauge. (As to the voltage of the pressure sensor, make measurement of voltage at the connector, and then convert it to pressure according to **Check No.4** .)
- *2. **Check No.3** Measure the voltage of the pressure sensor.



Refer to Check No. 3, 4, 6 on page 365, 366, 371.

Remote Controller Display

E4

Applicable Models

VRV III, III-S and WII Series

Method of Malfunction Detection

Judge the pressure detected by a low pressure sensor with the main PC board.

Malfunction Decision Conditions

When low pressure drops while the compressor is in operation

Working pressure: 0.07 MPa

(Retry: 3 times)

Supposed Causes

- Abnormal low pressure drop
- Faulty low pressure sensor
- Faulty main PC board
- The stop valve left closed
- Insufficient heat source water
- Dirty water heat exchanger

Troubleshooting



Caution

Be sure to turn off power switch before connect or disconnect connector, or parts damage may be occurred.

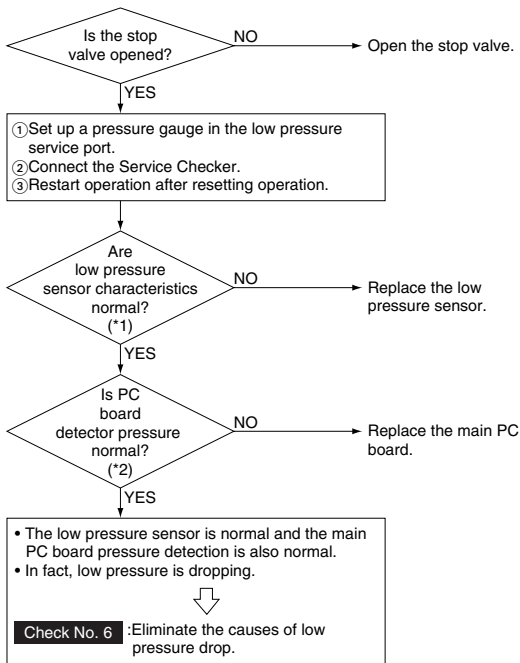

E4

- *1 : Make a comparison between the voltage of the pressure sensor and that read by the pressure gauge. (As to the voltage of the pressure sensor, make measurement of voltage at the connector, and then convert it to pressure according to **Check No.4** .)
- *2 : Compare “low pressure” measured with the Service Checker with pressure sensor voltage measurements (refer to **Check No.4**).
- *3. **Check No.3** Measure the voltage of the pressure sensor.



Refer to Check No. 3, 4, 6 on page 365, 366, 371.

(17) Compressor Motor Lock

Remote Controller Display

E5

Applicable Models

VRV II, II-S, III-S and VII Series

Method of Malfunction Detection

Inverter PC board takes the position signal from UVWN line connected between the inverter and compressor, and detects the position signal pattern.

Malfunction Decision Conditions

The position signal with 3 times cycle as imposed frequency is detected when compressor motor operates normally, but 2 times cycle when compressor motor locks. When the position signal in 2 times cycle is detected.

E4

E5

Supposed Causes

- Compressor lock
- High differential pressure (0.5MPa or more)
- Incorrect UVWN wiring
- Faulty inverter PC board
- Stop valve is left in closed.

Troubleshooting



Caution

Be sure to turn off power switch before connect or disconnect connector, or parts damage may be occurred.

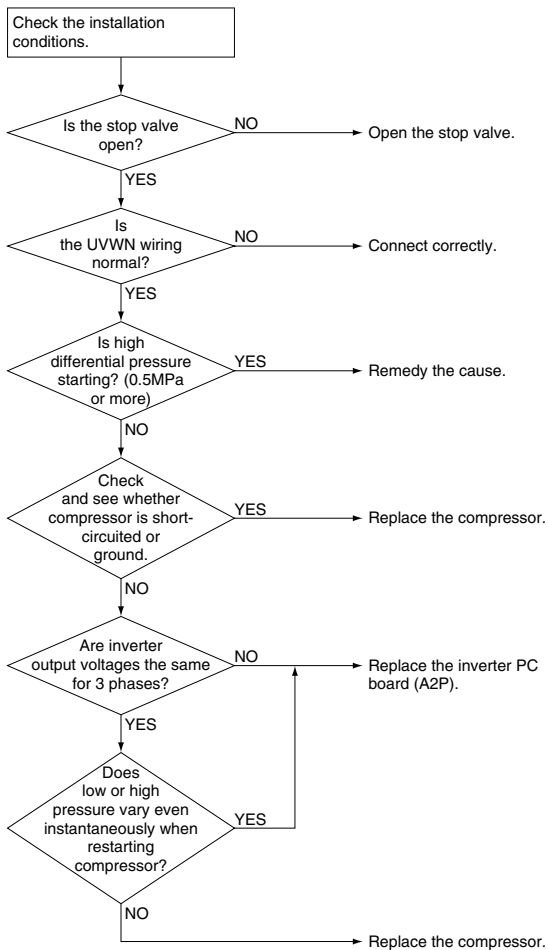

Remote Controller Display

E5

Applicable Models

VRV III H/R Series

Method of Malfunction Detection

Inverter PC board takes the position signal from UVW line connected between the inverter and compressor, and the malfunction is detected when any abnormality is observed in the phase-current waveform.

Malfunction Decision Conditions

This malfunction will be output when the inverter compressor motor does not start up even in forced startup mode.

E5

Supposed Causes

- Inverter compressor lock
- High differential pressure (0.5MPa or more)
- Incorrect UVW wiring
- Faulty inverter PC board
- Stop valve is left in closed.

Troubleshooting



Caution

Be sure to turn off power switch before connect or disconnect connector, or parts damage may be occurred.

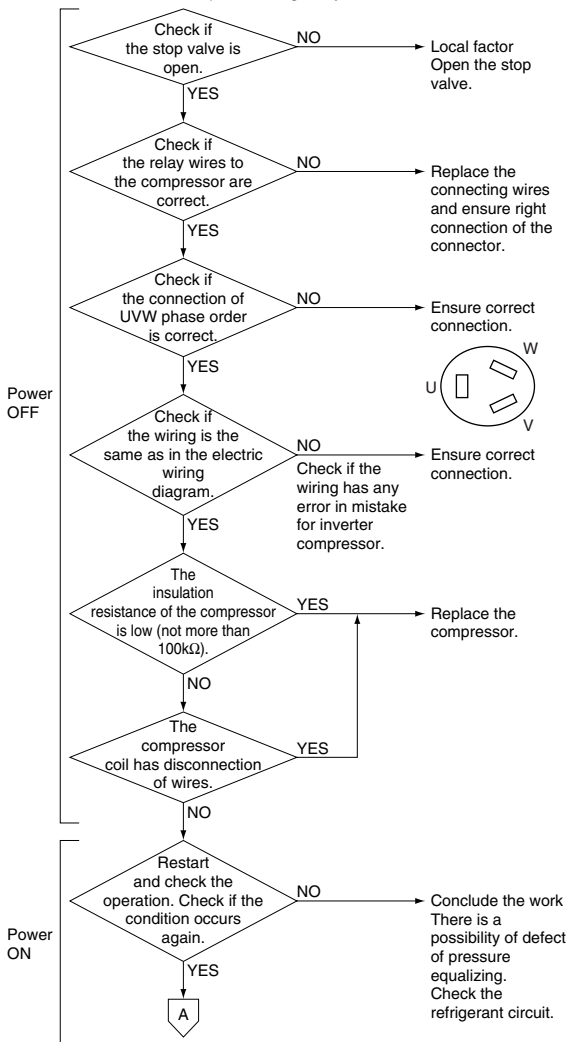



Caution

Be sure to turn off power switch before connect or disconnect connector, or parts damage may be occurred.

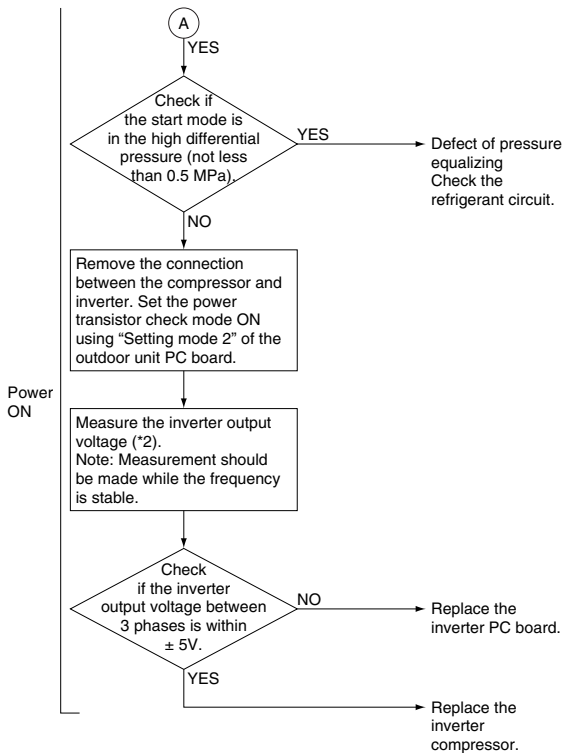

E5

*1: Pressure difference between high pressure and low pressure before starting.

*2: The quality of power transistors / diode modules can be judged by executing **Check No. 17** .



Refer to Check No. 17 on page 391.

Remote Controller Display

E5

Applicable Models

VRV III Series

Method of Malfunction Detection

Inverter PC board takes the position signal from UVW line connected between the inverter and compressor, and the malfunction is detected when any abnormality is observed in the phase-current waveform.

Malfunction Decision Conditions

This malfunction will be output when the inverter compressor motor does not start up even in forced startup mode.

Supposed Causes

- Inverter compressor lock
- High differential pressure (0.5MPa or more)
- Incorrect UVW wiring
- Faulty inverter PC board
- Stop valve is left in closed.

Troubleshooting



Caution

Be sure to turn off power switch before connect or disconnect connector, or parts damage may be occurred.

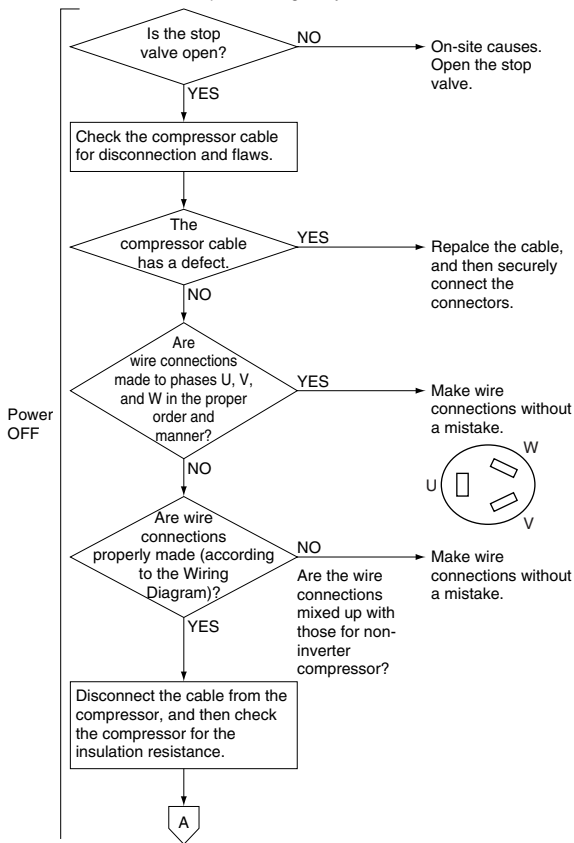

E5



Caution

Be sure to turn off power switch before connect or disconnect connector, or parts damage may be occurred.

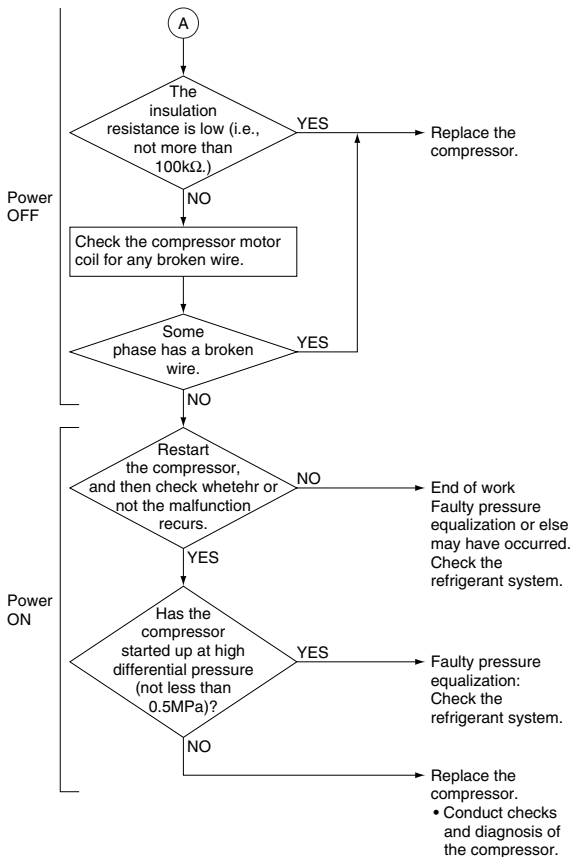

(18) STD Compressor Motor Overcurrent/ Lock

Remote Controller Display

E6

Applicable Models

VRV II, VRV III H/P (60Hz), H/R, C/O Series

Method of Malfunction Detection

Detects the overcurrent with current sensor (CT).

Malfunction Decision Conditions

Malfunction is decided when the detected current value exceeds the below mentioned value for 2 seconds.

- 400 V unit : 15.0 A

Supposed Causes

- Closed stop valve
- Obstacles at the discharge port
- Improper power voltage
- Faulty magnetic switch
- Faulty compressor

E5

E6

Troubleshooting



Caution

Be sure to turn off power switch before connect or disconnect connector, or parts damage may be occurred.

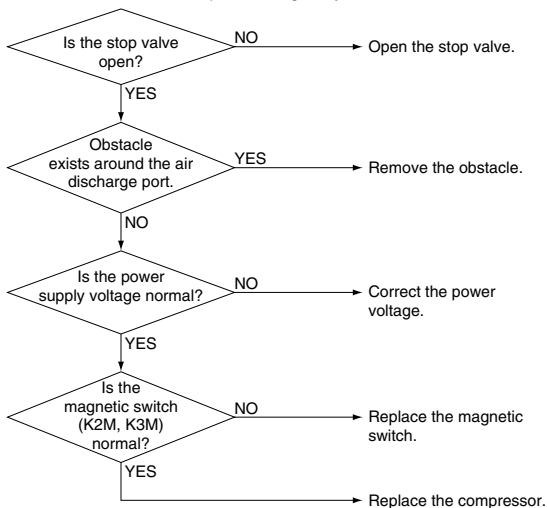

Remote Controller Display

E6

Applicable Models

VRV III H/P (50Hz) Series

Method of Malfunction Detection

Detects the overcurrent with current sensor (CT).

Malfunction Decision Conditions

Malfunction is decided when the detected current value exceeds the below mentioned value for 2 seconds.

- 400 V unit : 15.0 A

Supposed Causes

- Closed stop valve
- Obstacles at the air outlet
- Improper power voltage
- Faulty magnetic switch
- Faulty compressor
- Faulty current sensor (A6P, A7P)

E6

Troubleshooting



Caution

Be sure to turn off power switch before connect or disconnect connector, or parts damage may be occurred.

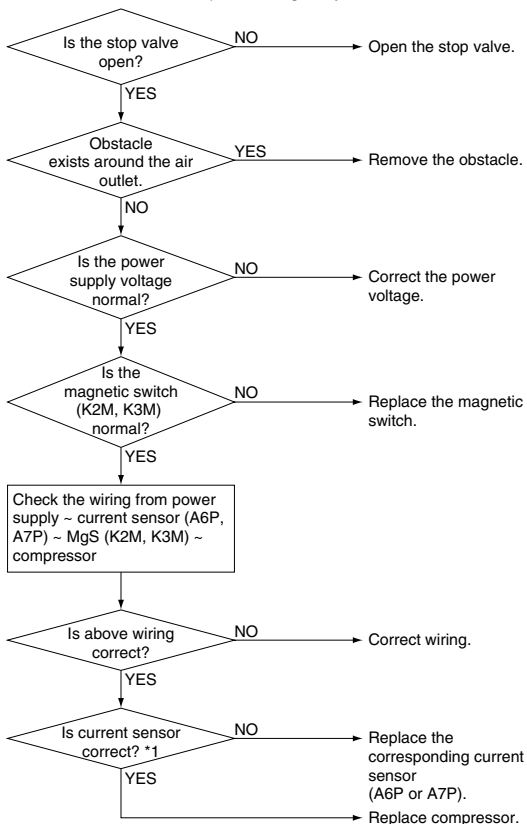

i Note:

*1 Abnormal case

- The current sensor value is 0 during STD compressor operation.
- The current sensor value is more than 15.0A during STD compressor stop.

E6

(19) Malfunction of Outdoor Unit Fan Motor

Remote Controller Display

E7

Applicable Models

VRV II Series

Method of Malfunction Detection

Malfunction of fan motor system is detected according to the fan speed detected by hall IC when the fan motor runs.

Malfunction Decision Conditions

- When the fan runs with speed less than a specified one for 15 seconds or more when the fan motor running conditions are met
- When connector detecting fan speed is disconnected
- When malfunction is generated 4 times, the system shuts down.

Supposed Causes

- Malfunction of fan motor
- The harness connector between fan motor and PC board is left in disconnected, or faulty connector
- Fan does not run due to foreign matters tangled
- Clearing condition: Operate for 5 minutes (normal)

Troubleshooting



Caution

Be sure to turn off power switch before connect or disconnect connector, or parts damage may be occurred.

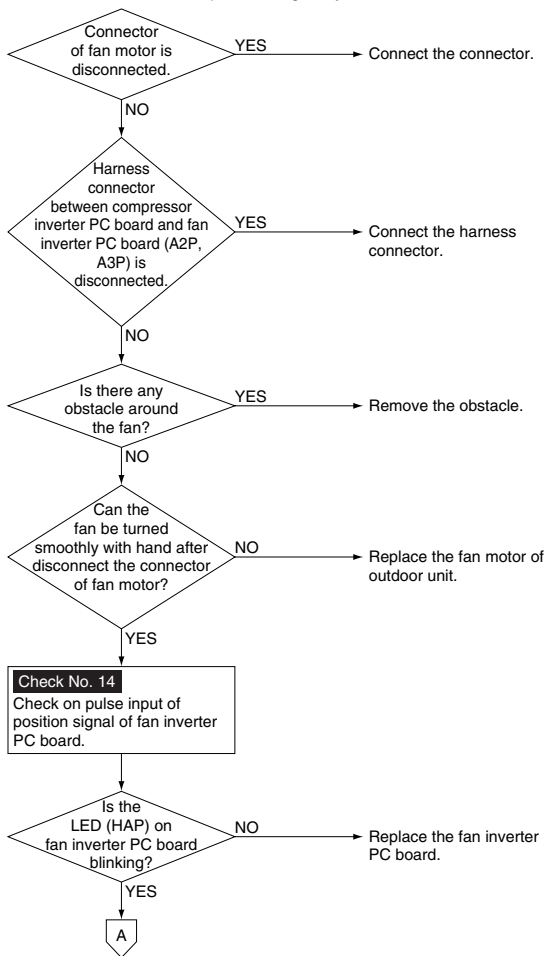

E7



Caution

Be sure to turn off power switch before connect or disconnect connector, or parts damage may be occurred.

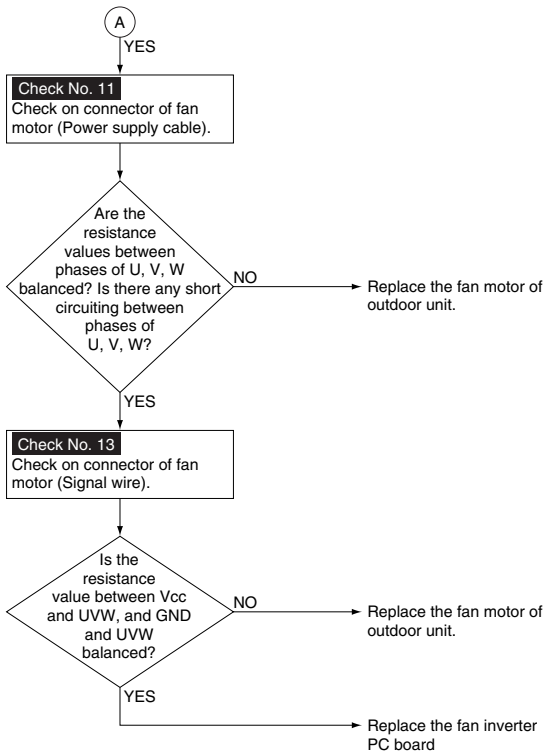

Refer to Check No. 11, 13, 14 on page 385, 387, 388.

Remote Controller Display

E7

Applicable Models

VRV III H/R and C/O Series

Method of Malfunction Detection

Detect a malfunction based on the current value in the INVERTER PC board (as for motor 2, current value in the fan PC board).

Detect a malfunction for the fan motor circuit based on the number of rotation detected by hole IC during the fan motor operation.

Malfunction Decision Conditions

- Overcurrent is detected for INVERTER PC board (A2P) or fan INVERTER PC board (A5P) (System down is caused by 4 times of detection.)
- In the condition of fan motor rotation, the number of rotation is below the fixed number for more than 6 seconds. (System down is caused by 4 times of detection.)

E7

Supposed Causes

- Failure of fan motor
- Defect or connection error of the connectors/ harness between the fan motor and PC board
- The fan can not rotate due to any foreign substances entangled.
- Clear condition: Continue normal operation for 5 minutes

Troubleshooting



Caution

Be sure to turn off power switch before connect or disconnect connector, or parts damage may be occurred.

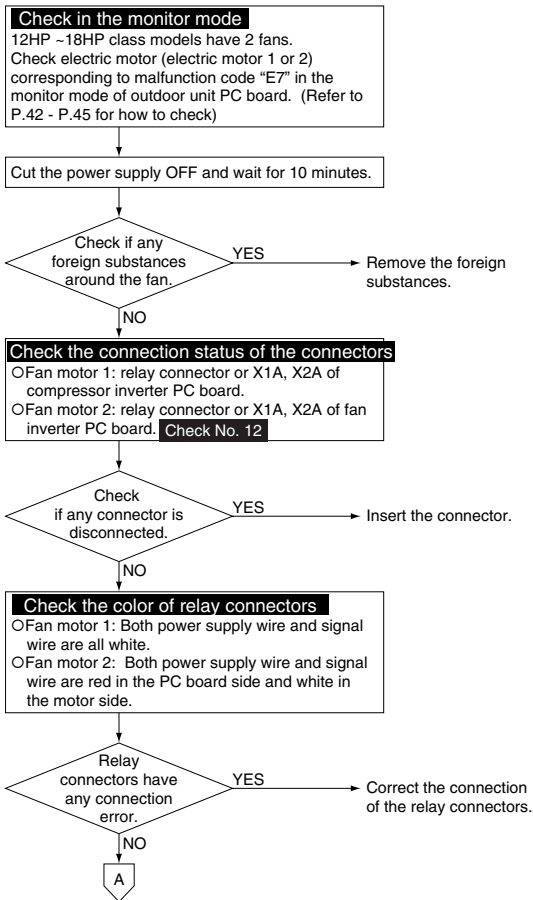

Refer to Check No. 12 on page 386.

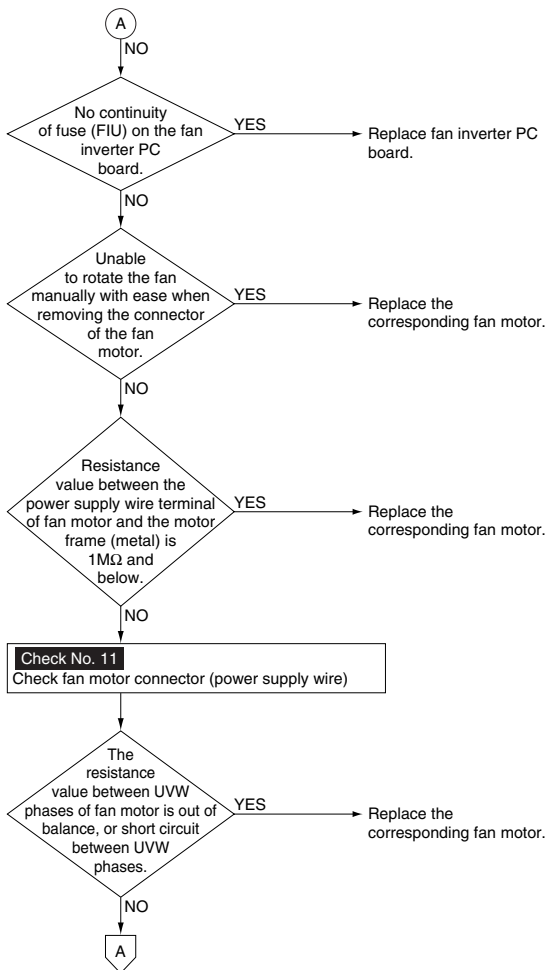

E7



Refer to Check No. 11 on page 385.

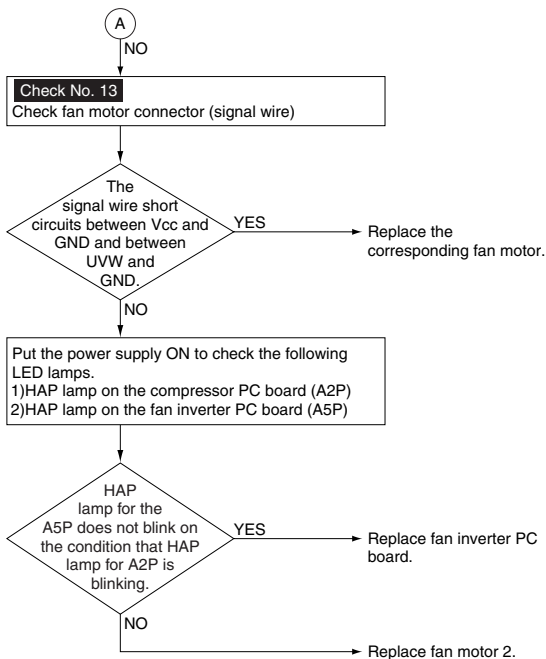

Refer to Check No. 13 on page 387.

Remote Controller Display

E7

Applicable Models

VRV III-S 50/60Hz Series

Method of Malfunction Detection

Malfunction of fan motor system is detected according to the fan speed detected by hall IC when the fan motor runs.

Malfunction Decision Conditions

- When the fan runs with speed less than a specified one for 6 seconds or more when the fan motor running conditions are met
- When malfunction is generated 4 times, the system shuts down.

E7

Supposed Causes

- Malfunction of fan motor
- The harness connector between fan motor and PC board is left in disconnected, or faulty connector
- Fan does not run due to foreign matters tangled
- Clearing condition: Operate for 5 minutes (normal)

Troubleshooting



Caution

Be sure to turn off power switch before connect or disconnect connector, or parts damage may be occurred.

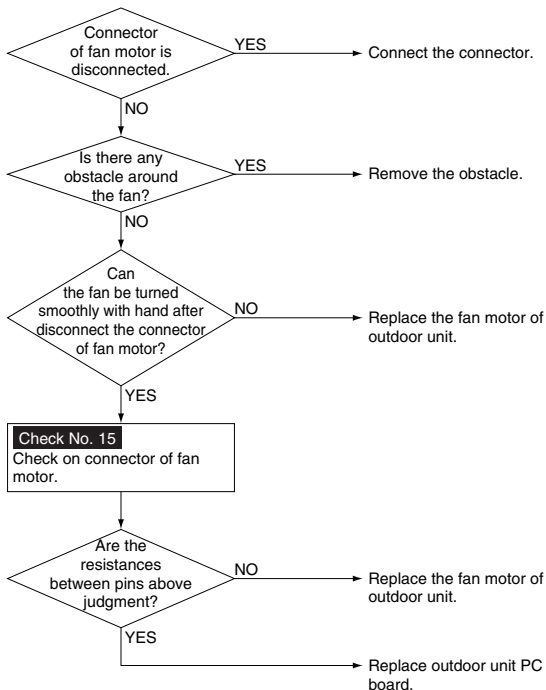

Refer to Check No. 15 on page 389.

Remote Controller Display

E7

Applicable Models

VRV III H/P Series

Method of Malfunction Detection

Malfunction of fan motor system is detected according to the fan speed detected by hall IC when the fan motor runs.

Malfunction Decision Conditions

- When the fan runs with speed less than a specified one for 6 seconds or more when the fan motor running conditions are met
- When connector detecting fan speed is disconnected
- When malfunction is generated 4 times, the system shuts down.

E7

Supposed Causes

- Malfunction of fan motor
- The harness connector between fan motor and PC board is left in disconnected, or faulty connector
- Fan does not run due to foreign matters tangled
- Clearing condition: Operate for 5 minutes (normal)

Troubleshooting



Caution

Be sure to turn off power switch before connect or disconnect connector, or parts damage may be occurred.

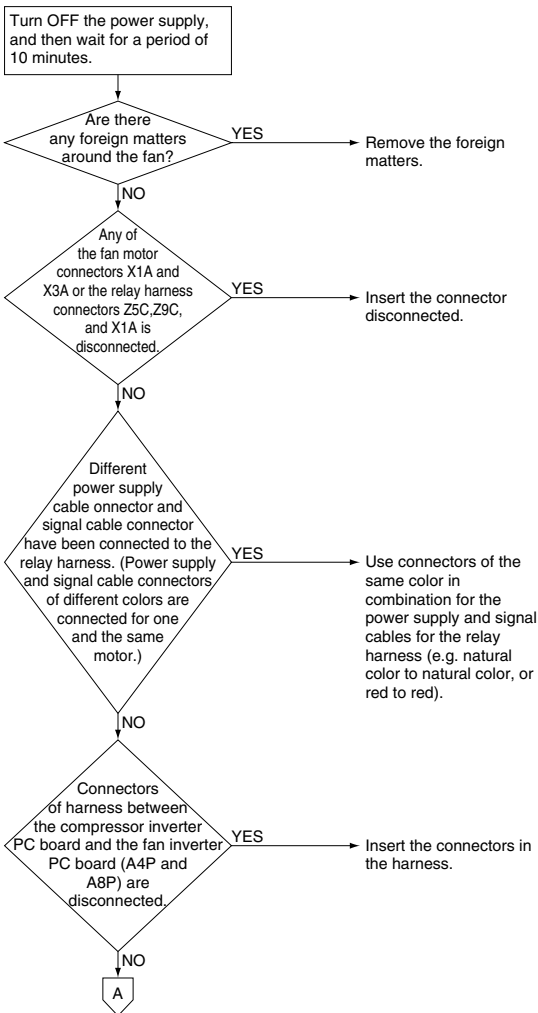

**Caution**

Be sure to turn off power switch before connect or disconnect connector, or parts damage may be occurred.

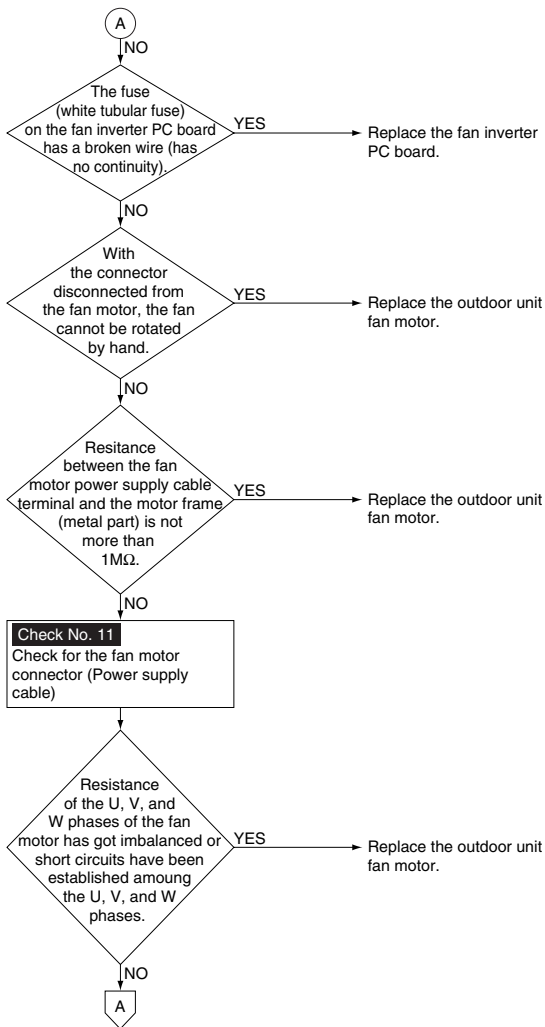
**E7**



Caution

Be sure to turn off power switch before connect or disconnect connector, or parts damage may be occurred.

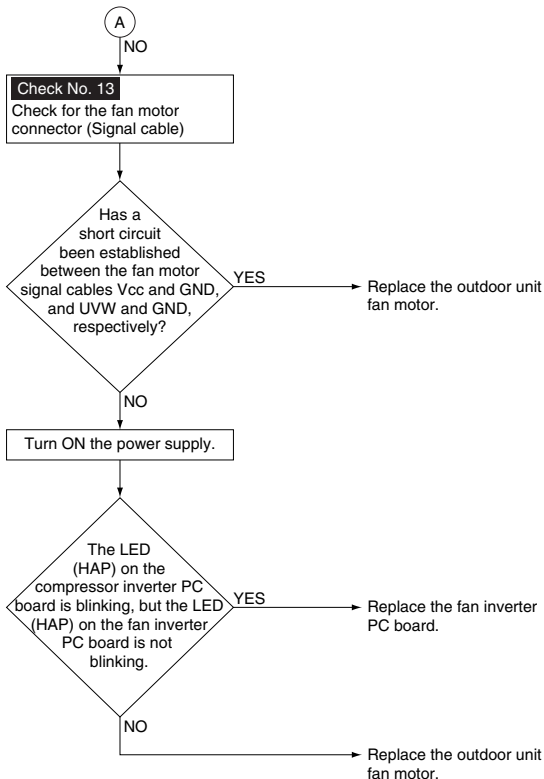

Refer to Check No. 11, 13 on page 385, 387.

Remote Controller Display

E7

Applicable Models

VRV III-S (50Hz) Series

Method of Malfunction Detection

Malfunction of fan motor system is detected according to the fan speed detected by hall IC when the fan motor runs.

Malfunction Decision Conditions

- When the fan runs with speed less than a specified one for 6 seconds or more when the fan motor running conditions are met
- When malfunction is generated 4 times, the system shuts down.

E7

Supposed Causes

- Malfunction of fan motor
- The harness connector between fan motor and PC board is left in disconnected, or faulty connector
- Fan does not run due to foreign matters tangled
- Clearing condition: Operate for 5 minutes (normal)
- Open phase L1 or open phase N.

Troubleshooting



Caution

Be sure to turn off power switch before connect or disconnect connector, or parts damage may be occurred.

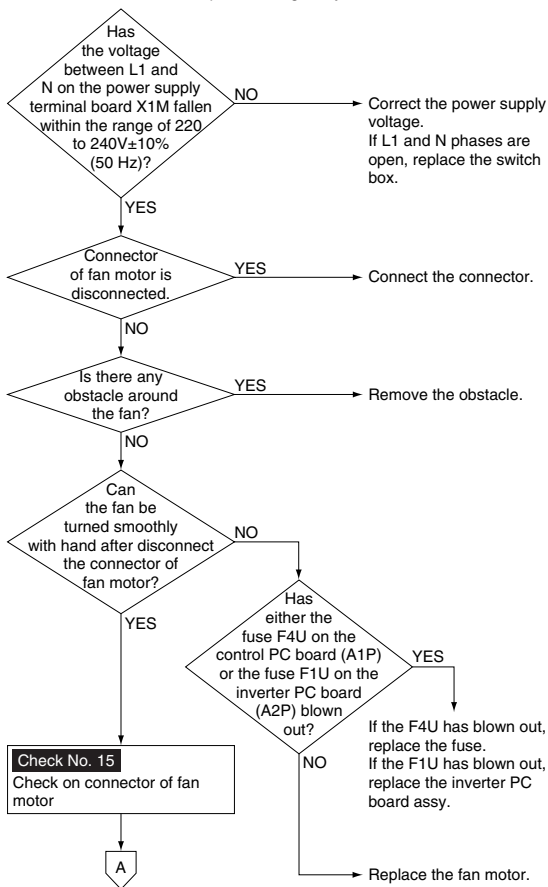

**Caution**

Be sure to turn off power switch before connect or disconnect connector, or parts damage may be occurred.

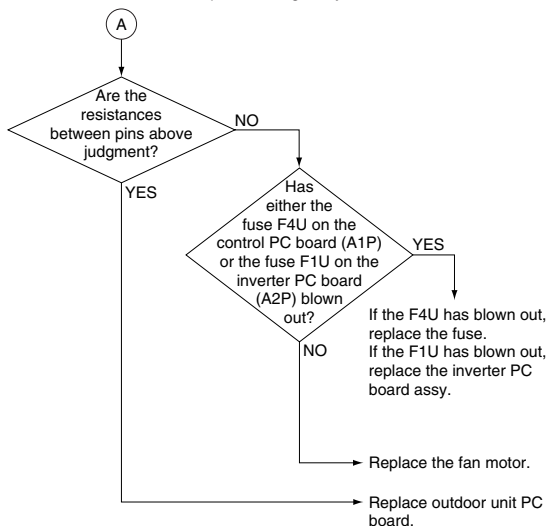
**E7**

Refer to Check No. 15 on page 389.

(20) Malfunction of Moving Part of Electronic Expansion Valve (Y1E, Y2E)

Remote Controller Display

E9

Applicable Models

VRV II, III (60Hz), III-S and VII Series

Method of Malfunction Detection

- Check disconnection of connector
- Check continuity of expansion valve coil

Malfunction Decision Conditions

Error is generated under no common power supply when the power is on.

Supposed Causes

- Defect of moving part of electronic expansion valve
- Defect of outdoor unit PC board (A1P)
- Defect of connecting cable

Troubleshooting

 **Caution** Be sure to turn off power switch before connect or disconnect connector, or parts damage may be occurred.

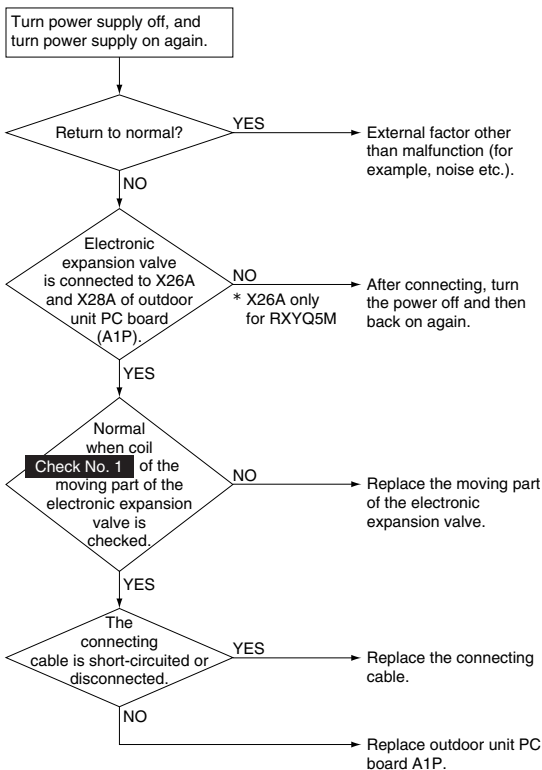

E9



Refer to Check No. 1 on page 360.

Remote Controller Display

E9

Applicable Models

VRV III H/R and C/O Series

Method of Malfunction Detection

Check disconnection of connector

To be detected based on continuity existence of coil of electronic expansion valve

Malfunction Decision Conditions

No current is detected in the common (COM [+]) when power supply is ON.

Supposed Causes

- Disconnection of connectors for electronic expansion valve (Y1E)
- Defect of moving part of electronic expansion valve
- Defect of outdoor unit main PC board (A1P)

Troubleshooting

Caution

Be sure to turn off power switch before connect or disconnect connector, or parts damage may be occurred.

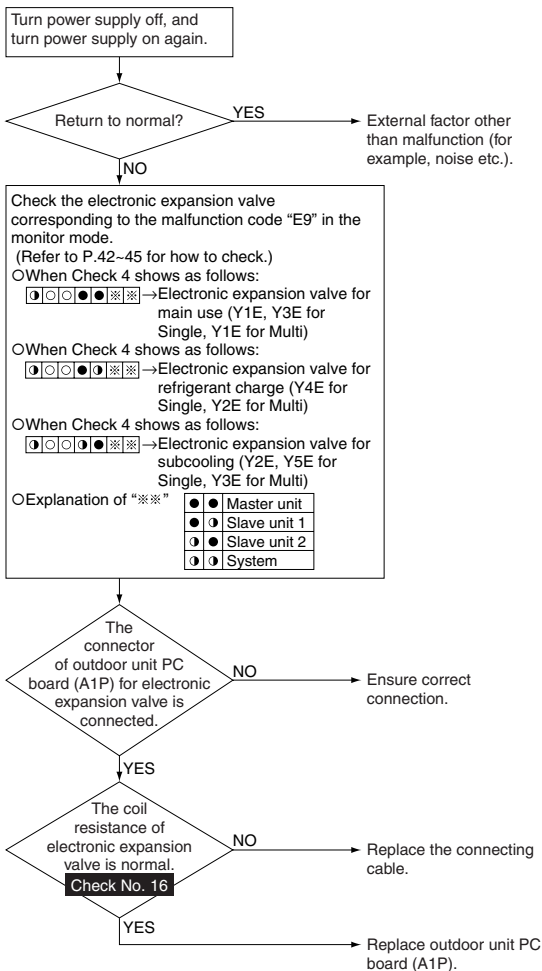
E9

Refer to Check No. 16 on page 390.

Remote Controller Display

E9

Applicable Models

VRV II-S Series

Method of Malfunction Detection

- Check disconnection of connector
- Check continuity of expansion valve coil

Malfunction Decision Conditions

Error is generated under no common power supply when the power is on.

Supposed Causes

- Defect of moving part of electronic expansion valve
- Defect of outdoor unit PC board (A1P)

Troubleshooting



Caution

Be sure to turn off power switch before connect or disconnect connector, or parts damage may be occurred.

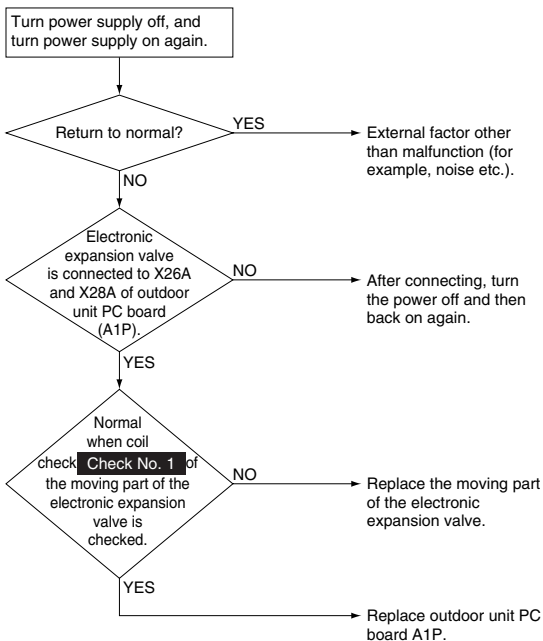

E9



Refer to Check No. 1 on page 360.

Remote Controller Display

E9

Applicable Models

VRV III and III-S Series

Method of Malfunction Detection

- Check disconnection of connector
- Check continuity of expansion valve coil

Malfunction Decision Conditions

Error is generated under no common power supply when the power is on.

Supposed Causes

- Defect of moving part of electronic expansion valve
- Defect of outdoor unit PC board (A1P)
- Defect of connecting cable

Troubleshooting



Caution

Be sure to turn off power switch before connect or disconnect connector, or parts damage may be occurred.

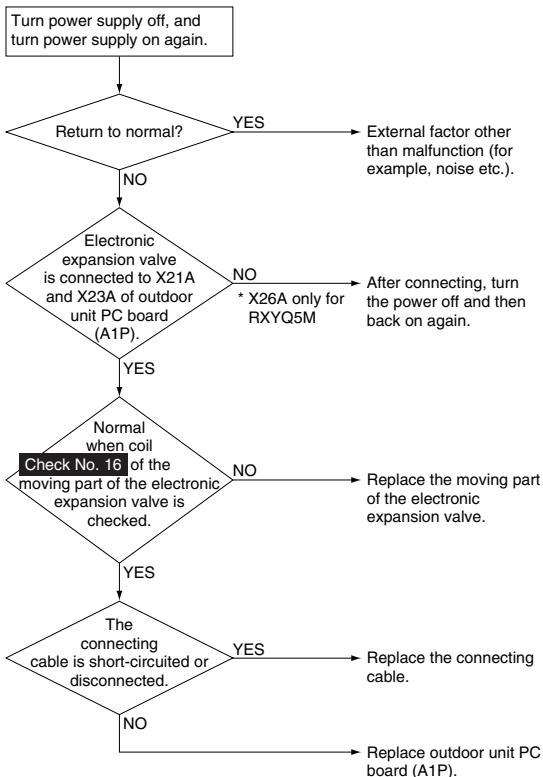

E9



Refer to Check No. 16 on page 390.

(21) Abnormal Discharge Pipe Temperature

Remote Controller Display

F3

Applicable Models

VRV II, III 60Hz, II-S and III-S Series

Method of Malfunction Detection

Abnormality is detected according to the temperature detected by the discharge pipe temperature sensor.

Malfunction Decision Conditions

When the discharge pipe temperature rises to an abnormally high level

When the discharge pipe temperature rises suddenly

Supposed Causes

- Faulty discharge pipe temperature sensor
- Faulty connection of discharge pipe temperature sensor
- Faulty outdoor unit PC board

Troubleshooting



Caution

Be sure to turn off power switch before connect or disconnect connector, or parts damage may be occurred.

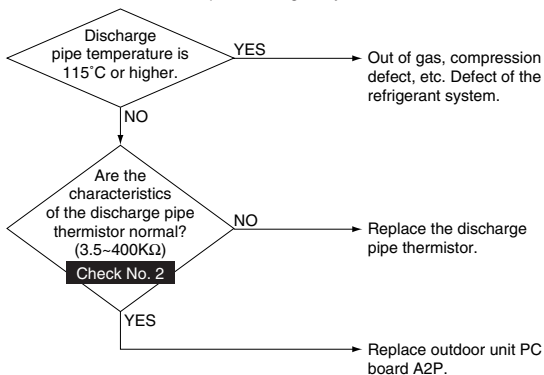

F3



Refer to Check No. 2 on page 361.

Remote Controller Display

F3

Applicable Models

VRV III H/R and C/O Series

Method of Malfunction Detection

Abnormality is detected according to the temperature detected by the discharge pipe temperature sensor.

Malfunction Decision Conditions

When the discharge pipe temperature rises to an abnormally high level (135 °C and above)

When the discharge pipe temperature rises suddenly (120 °C and above for 10 successive minutes)

Supposed Causes

- Faulty discharge pipe temperature sensor
- Faulty connection of discharge pipe temperature sensor
- Faulty outdoor unit PC board

Troubleshooting

 **Caution** Be sure to turn off power switch before connect or disconnect connector, or parts damage may be occurred.

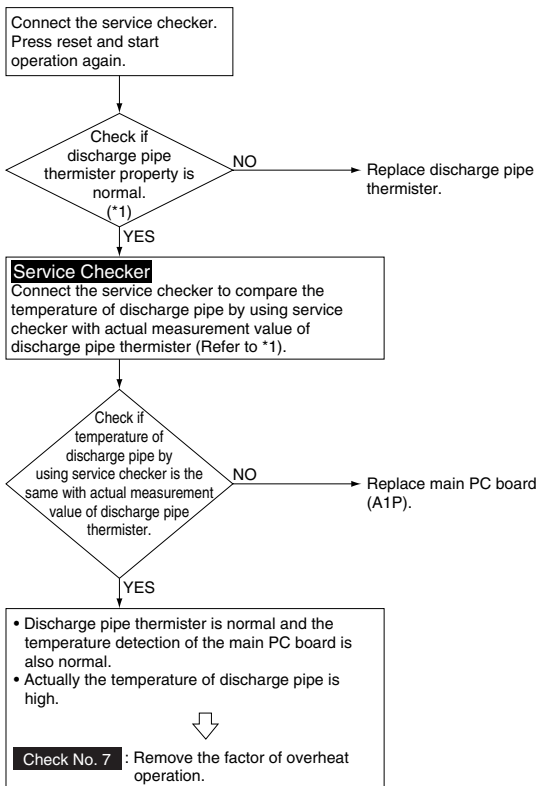

F3

*1: Compare the resistance value of discharge pipe thermister and the value based on the surface thermometer.

(Refer to **Check No.2** for the temperature of thermister and the resistance property)



Refer to Check No. 2, 7 on page 361, 375.

Remote Controller Display

F3

Applicable Models

VRV WII Series

Method of Malfunction Detection

Abnormality is detected according to the temperature detected by the discharge pipe temperature sensor.

Malfunction Decision Conditions

When the discharge pipe temperature rises to an abnormally high level (over 135°C)

When the discharge pipe temperature rises suddenly (over 120°C continues 10 min.)

Supposed Causes

- Faulty discharge pipe temperature sensor
- Faulty connection of discharge pipe temperature sensor
- Faulty outside unit PC board

Troubleshooting



Caution

Be sure to turn off power switch before connect or disconnect connector, or parts damage may be occurred.

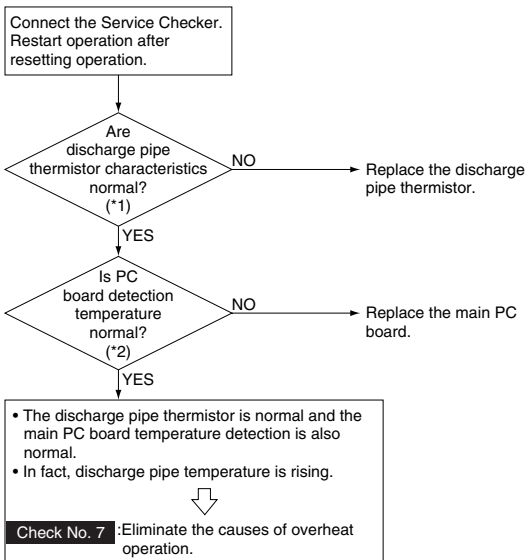

F3

*1: Compare the resistance values of the discharge pipe thermistor with measurements of a surface thermometer.

(For temperature and resistance characteristics of a thermistor, refer to **Check No.2** .)

*2 : Compare the discharge pipe temperature checked by the Service.

Checker with the resistance of the thermistor (refer to *1).



Refer to Check No. 2, 7 on page 361, 375.

Remote Controller Display

F3

Applicable Models

VRV III and III-S Series

Method of Malfunction Detection

Abnormality is detected according to the temperature detected by the discharge pipe temperature sensor.

Malfunction Decision Conditions

When the discharge pipe temperature rises to an abnormally high level

When the discharge pipe temperature rises suddenly

Supposed Causes

- Faulty discharge pipe temperature sensor
- Faulty connection of discharge pipe temperature sensor
- Faulty outdoor unit PC board

Troubleshooting



Caution

Be sure to turn off power switch before connect or disconnect connector, or parts damage may be occurred.

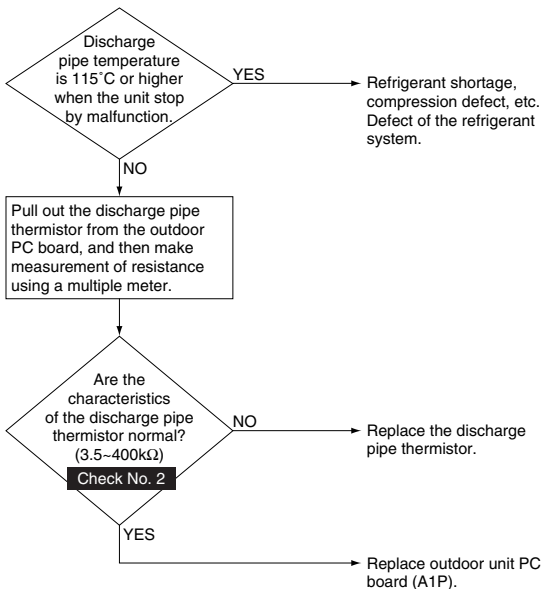

F3



Refer to Check No. 2 on page 361.

(22) “F6” Refrigerant Overcharged

Remote Controller Display

F6

Applicable Models

VRV II Series

Method of Malfunction Detection

Refrigerant overcharge is detected from the receiver gas pipe temperature during test operation.

Malfunction Decision Conditions

When the receiver gas pipe temperature is lower than evaporating temperature during test operation.

Supposed Causes

- Refrigerant overcharge
- Disconnection of the receiver gas pipe thermistor

Troubleshooting



Caution

Be sure to turn off power switch before connect or disconnect connector, or parts damage may be occurred.

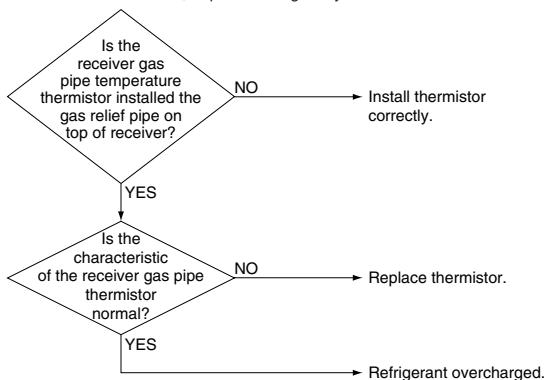

Remote Controller Display

F6

Applicable Models

VRV III and III-S Series

Method of Malfunction Detection

Excessive charging of refrigerant is detected by using the outside air temperature, heat exchanging deicer temperature and liquid pipe temperature during a check run.

Malfunction Decision Conditions

When the amount of refrigerant, which is calculated by using the outside air temperature, heat exchanging deicer temperature and liquid pipe temperature during a check run, exceeds the standard.

F6

Supposed Causes

- Refrigerant overcharge
- Misalignment of the outside air thermistor
- Misalignment of the heat exchanging deicer thermistor
- Misalignment of the liquid pipe thermistor

Troubleshooting



Caution

Be sure to turn off power switch before connect or disconnect connector, or parts damage may be occurred.

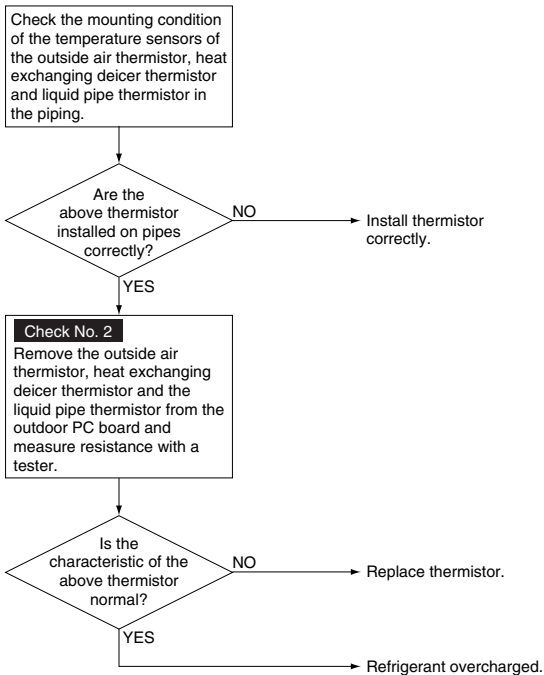

Refer to Check No. 2 on page 361.

Remote Controller Display

F6

Applicable Models

VRV WII Series

Method of Malfunction Detection

Detect excessive charging of refrigerant using suction pipe temperature and subcooling heat exchanger outlet temperature during check operation.

Malfunction Decision Conditions

When the suction pipe temperature and the subcooling heat exchanger outlet temperature during check operation drop and become below the evaporation temperature

F6

Supposed Causes

- Excessive refrigerant charging
- Suction pipe thermistor removed
- Subcooling heat exchanger outlet thermistor removed

Troubleshooting



Caution

Be sure to turn off power switch before connect or disconnect connector, or parts damage may be occurred.

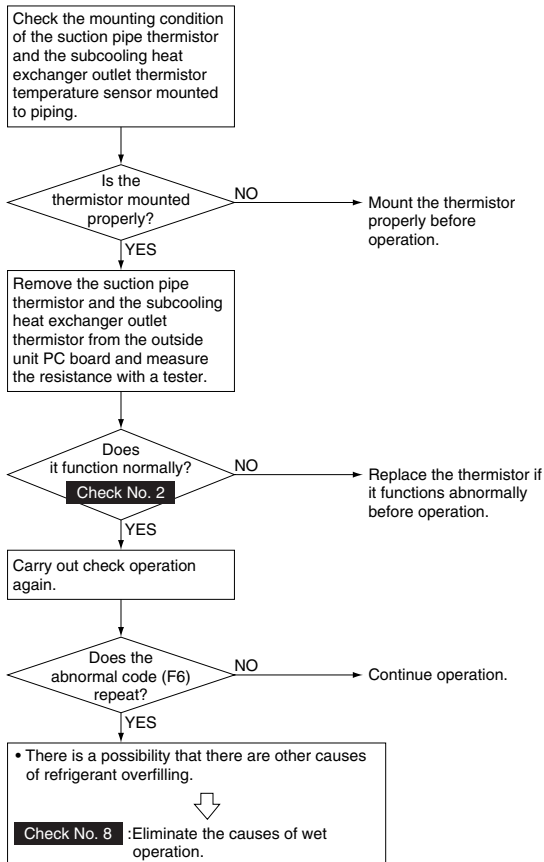

Refer to Check No. 2, 8 on page 361, 379.

Remote Controller Display

F6

Applicable Models

VRV III-S Series

Method of Malfunction Detection

Excessive charging of refrigerant is detected by using the heat exchanging deicer temperature during a check operation.

Malfunction Decision Conditions

When the amount of refrigerant, which is calculated by using the heat exchanging deicer temperature during a check run, exceeds the standard.

Supposed Causes

- Refrigerant overcharge
- Misalignment of the thermistor for heat exchanger
- Defect of the thermistor for heat exchanger

F6

Troubleshooting



Caution

Be sure to turn off power switch before connect or disconnect connector, or parts damage may be occurred.

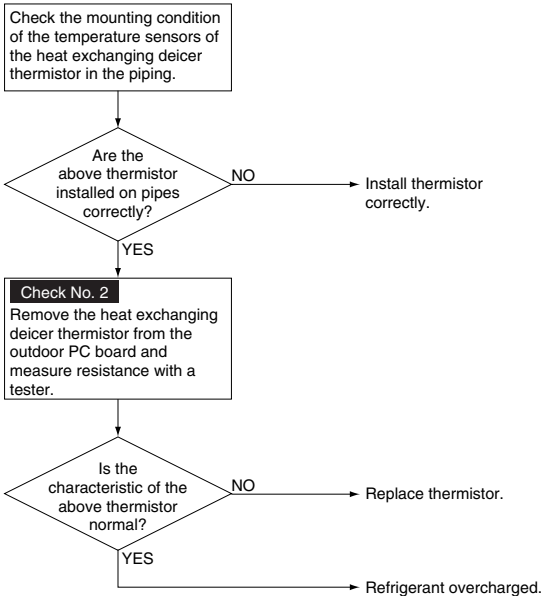

Refer to Check No. 2 on page 361.

(23) Abnormal Outdoor Fan Motor Signal

Remote Controller Display

H7

Applicable Models

VRV II and III Series

Method of Malfunction Detection

Detection of abnormal signal from fan motor.

Malfunction Decision Conditions

In case of detection of abnormal signal at starting fan motor.

Supposed Causes

- Abnormal fan motor signal (circuit malfunction)
- Broken, short or disconnection connector of fan motor connection cable
- Fan Inverter PC board malfunction

F6

H7

Troubleshooting



Caution

Be sure to turn off power switch before connect or disconnect connector, or parts damage may be occurred.

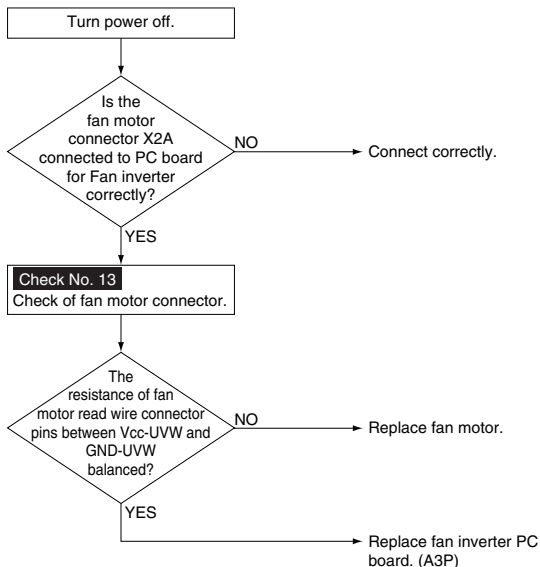

Refer to Check No. 13 on page 387.

(24) “H9” Outdoor Unit: Malfunction of Thermistor for Outdoor Air (R1T)

Remote Controller Display

H9

Applicable Models

except VRV WII Series

Method of Malfunction Detection

The abnormal detection is based on current detected by current sensor.

Malfunction Decision Conditions

When the outside air temperature sensor has short circuit or open circuit.

Supposed Causes

- Defect of thermistor (R1T) for outdoor air
- Defect of outdoor unit PC board (A1P)

H7

H9

Troubleshooting



Caution

Be sure to turn off power switch before connect or disconnect connector, or parts damage may be occurred.

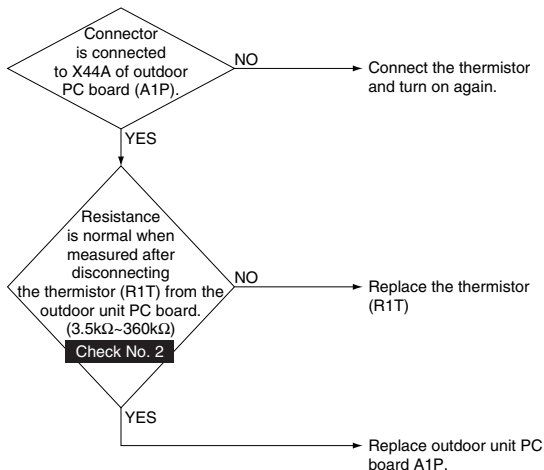

The alarm indicator is displayed when the fan only is being used also.



Refer to Check No. 2 on page 361.

(25) Malfunction of Water System

Remote Controller Display

HJ

Applicable Models

VRV WII Series

Method of Malfunction Detection

Detect abnormalities using the thermistor on the side of the heat exchanger gas.

Detect turned off interlock circuit.

(When interlock setting is provided.)

Malfunction Decision Conditions

When temperature on the heat exchanger gas side (R4T) drops remarkably with the smallest operation step (52 Hz) of the compressor

With interlock setting provided, when interlock circuit is turned off.

H9

HJ

Supposed Causes

- Clogged water piping system
- Insufficient heat exchanger water
- Dirty heat exchanger
- Disconnected connector
- Faulty thermistor on the heat exchanger gas side
- Faulty low pressure sensor

Troubleshooting



Caution

Be sure to turn off power switch before connect or disconnect connector, or parts damage may be occurred.

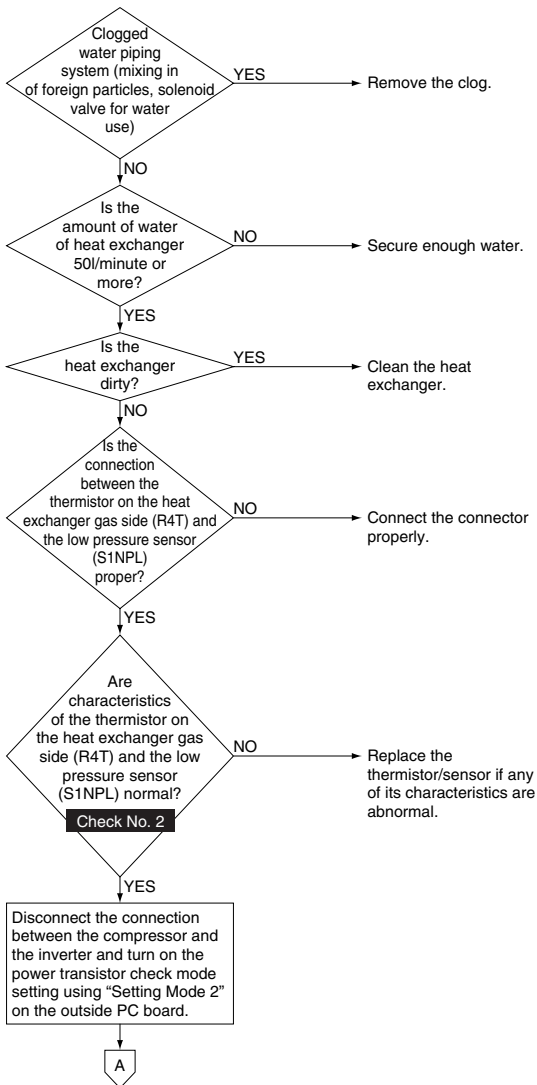

**Caution**

Be sure to turn off power switch before connect or disconnect connector, or parts damage may be occurred.

A

Measure the output voltage of the inverter. **Check No. 17**
Note: Take measurements while frequency is stable.

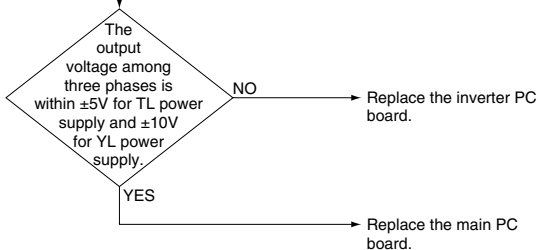
**HJ**

Refer to Check No. 2, 17 on page 361, 391.

(26) Current Sensor Malfunction

Remote Controller Display

U2

Applicable Models

VRV II and III (60Hz) Series

Method of Malfunction Detection

Malfunction is detected according to the current value detected by current sensor.

Malfunction Decision Conditions

When the current value detected by current sensor becomes 5A or lower, or 40A or more during standard compressor operation.

Supposed Causes

- Faulty current sensor
- Faulty outdoor unit PC board

Troubleshooting



Caution

Be sure to turn off power switch before connect or disconnect connector, or parts damage may be occurred.

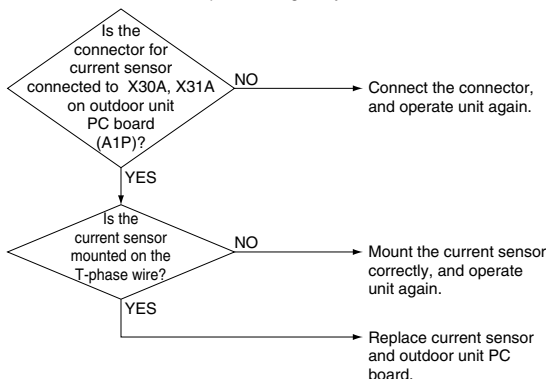

Remote Controller Display

J2

Applicable Models

VRV III H/R Series

Method of Malfunction Detection

Malfunction is detected according to the current value detected by current sensor.

Malfunction Decision Conditions

When the current value detected by current sensor becomes 5A or lower, or 40A or more during standard compressor operation.

Supposed Causes

- Faulty current sensor (A6P, A8P)
- Faulty outdoor unit PC board
- Defective compressor

J2

Troubleshooting



Caution

Be sure to turn off power switch before connect or disconnect connector, or parts damage may be occurred.

Check the current sensor corresponding to the malfunction code "J2" in the monitor mode.
 (Refer to P.42~P.45 for how to check)

○Check 4 shows as follows:
 → Current sensor for constant rate compressor 1

○Check 4 shows as follows:
 → Current sensor for constant rate compressor 2

○Explanation for "※※"

● ●	Master unit
● ○	Slave unit 1
○ ●	Slave unit 2
○ ○	System

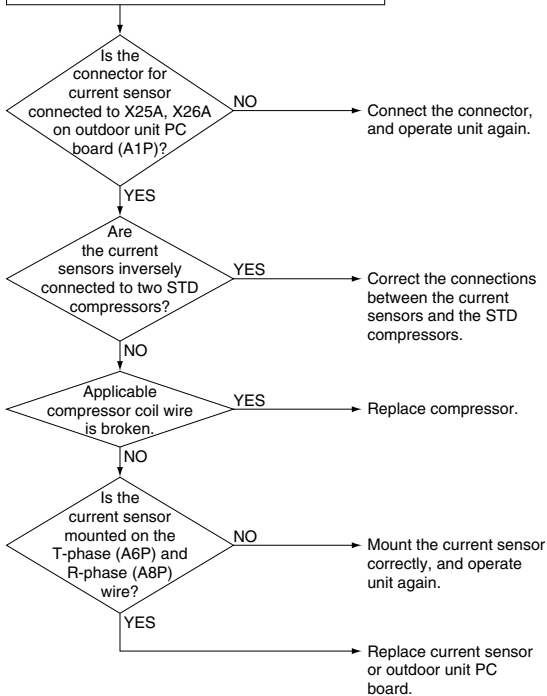

Remote Controller Display

J2

Applicable Models

VRV III C/O Series

Method of Malfunction Detection

Malfunction is detected according to the current value detected by current sensor.

Malfunction Decision Conditions

When the current value detected by current sensor becomes 5A or lower, or 40A or more during standard compressor operation.

Supposed Causes

- Faulty current sensor (A6P, A7P)
- Faulty outdoor unit PC board
- Defective compressor

J2

Troubleshooting



Caution

Be sure to turn off power switch before connect or disconnect connector, or parts damage may be occurred.

Check the current sensor corresponding to the malfunction code "J2" in the monitor mode.
 (Refer to P.42~P.45 for how to check)

○Check 4 shows as follows:
 → Current sensor for constant rate compressor 1

○Check 4 shows as follows:
 → Current sensor for constant rate compressor 2

○Explanation for "※※"

● ●	Master unit
● ○	Slave unit 1
○ ●	Slave unit 2
○ ○	System

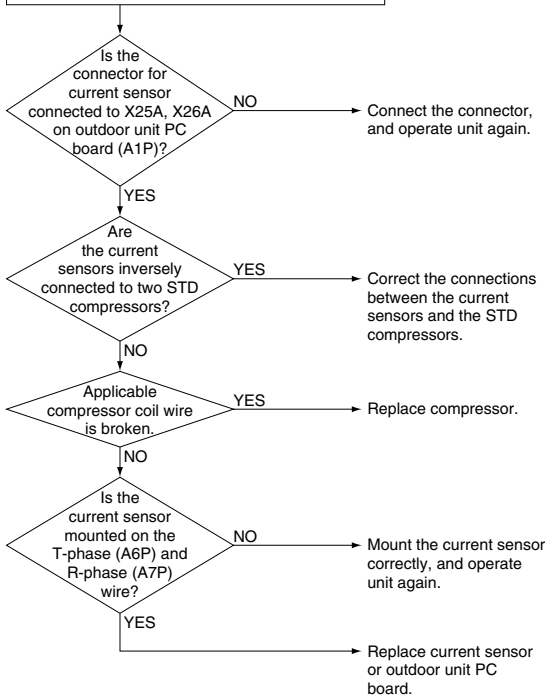

Remote Controller Display

J2

Applicable Models

VRV III H/P 50Hz Series

Method of Malfunction Detection

Malfunction is detected according to the current value detected by current sensor.

Malfunction Decision Conditions

When the current value detected by current sensor becomes 5A or lower, or 40A or more during standard compressor operation.

Supposed Causes

- Faulty current sensor (A6P, A7P)
- Faulty outdoor unit PC board

J2

Troubleshooting



Caution

Be sure to turn off power switch before connect or disconnect connector, or parts damage may be occurred.

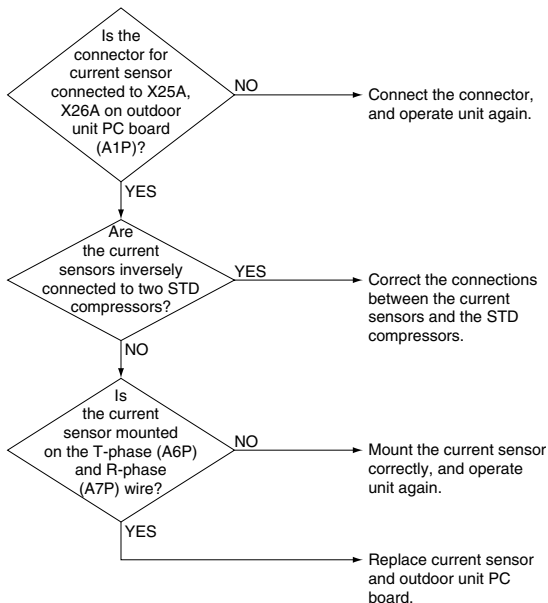

(27) Malfunction of Discharge Pipe Thermistor (R3, R31~33T)

Remote Controller Display

J3

Applicable Models

except VRV III H/P 50Hz Series

Method of Malfunction Detection

Malfunction is detected from the temperature detected by discharge pipe temperature thermistor.

Malfunction Decision Conditions

When a short circuit or an open circuit in the discharge pipe temperature thermistor is detected.

Supposed Causes

- Defect of thermistor (R31T, R32T or R33T) for outdoor unit discharge pipe
- Defect of outdoor unit PC board (A1P)

J2

J3

Troubleshooting



Caution

Be sure to turn off power switch before connect or disconnect connector, or parts damage may be occurred.

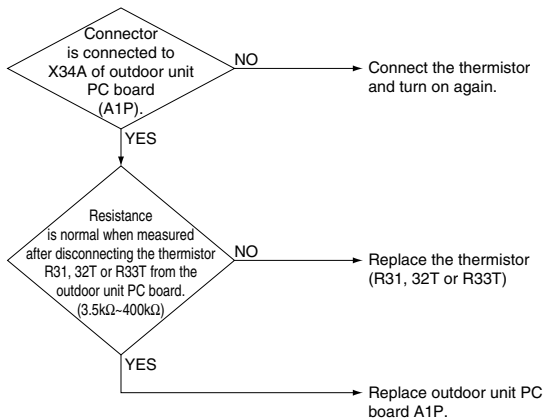

The alarm indicator is displayed when the fan is being used also.



Note:

5 HP class ... R3T

8~12 HP class ... R31T, R32T

14, 16HP class ... R31T, R32T and R33T

Remote Controller Display

J3

Applicable Models

VRV III H/P 50Hz Series

Method of Malfunction Detection

Malfunction is detected from the temperature detected by discharge pipe temperature thermistor.

Malfunction Decision Conditions

When a short circuit or an open circuit in the discharge pipe temperature thermistor is detected.

Supposed Causes

- Defect of thermistor (R31T, R32T or R33T) for outdoor unit discharge pipe
- Defect of outdoor unit PC board (A1P)
- Defect of thermistor connection

J3

Troubleshooting



Caution

Be sure to turn off power switch before connect or disconnect connector, or parts damage may be occurred.

Confirm which discharge thermistor is abnormal using outdoor unit "monitor mode".
(Refer to P.42~45)

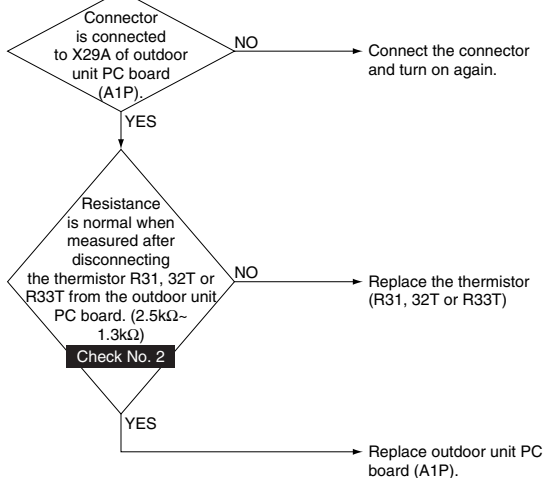

The alarm indicator is displayed when the fan is being used also.



Note:

5 HP class ... R3T

8~12 HP class ... R31T, R32T

14, 16HP class ... R31T, R32T and R33T



Refer to Check No. 2 on page 361.

(28) Malfunction of Temperature Sensor for Heat Exchanger Gas (R2T or R11T)

Remote Controller Display

J4

Applicable Models

VRV III H/R and WII Series

Method of Malfunction Detection

Detect malfunction based on the temperature detected by each thermistor.

Malfunction Decision Conditions

In operation, when a thermistor is disconnected or short circuits.

J3

J4

Supposed Causes

- Defective connection of thermistor
- Defective thermistor
- Defective outdoor unit PC board

Troubleshooting



Caution

Be sure to turn off power switch before connect or disconnect connector, or parts damage may be occurred.

Confirm which thermistor is abnormal using outdoor unit "monitor mode".
(Refer to P.42~45)

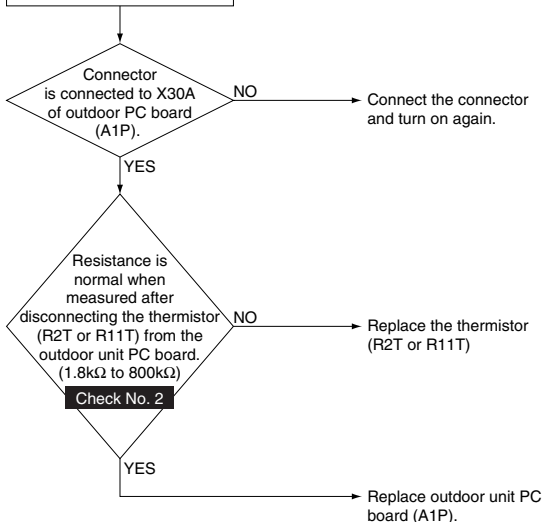

Refer to Check No. 2 on page 361.

(29) Malfunction of Thermistor (R2T) for Suction Pipe

Remote Controller Display

J5

Applicable Models

All indoor unit models

Method of Malfunction Detection

Malfunction is detected from the temperature detected by the suction pipe temperature thermistor.

Malfunction Decision Conditions

When a short circuit or an open circuit in the suction pipe temperature thermistor is detected.

Supposed Causes

- Defect of thermistor (R2T) for outdoor unit suction pipe
- Defect of outdoor unit PC board (A1P)

J4

J5

Troubleshooting



Caution

Be sure to turn off power switch before connect or disconnect connector, or parts damage may be occurred.

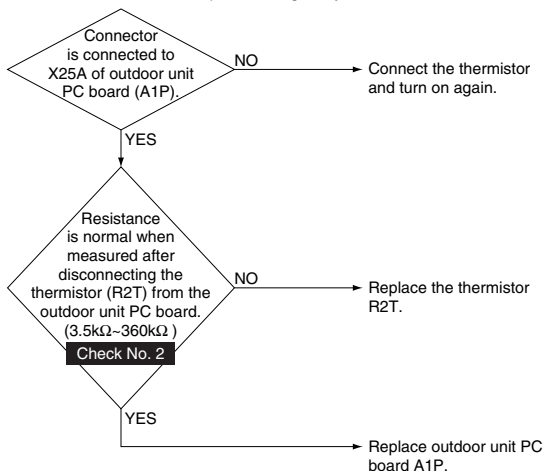

Refer to Check No. 2 on page 361.

(30) Malfunction of Thermistor (R4T) for Outdoor Unit Heat Exchanger

Remote Controller Display

J6

Applicable Models

except WII Series

Method of Malfunction Detection

Malfunction is detected from the temperature detected by the heat exchanger thermistor.

Malfunction Decision Conditions

When a short circuit or an open circuit in the heat exchange thermistor is detected.

Supposed Causes

- Defect of thermistor (R4T) for outdoor unit coil
- Defect of outdoor unit PC board (A1P)

J5

J6

Troubleshooting



Caution

Be sure to turn off power switch before connect or disconnect connector, or parts damage may be occurred.

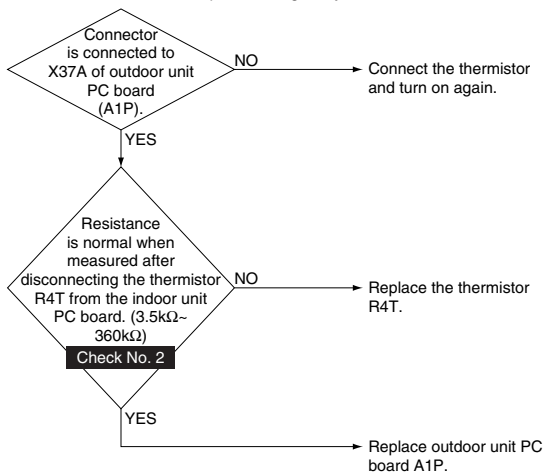

Refer to Check No. 2 on page 361.

(31) Malfunction of Liquid Pipe Thermistor 1 (R6T), (R9T)

Remote Controller Display

J7

Applicable Models

except VRV II and II-S

Method of Malfunction Detection

Malfunction is detected according to the temperature detected by liquid pipe thermistor.

Malfunction Decision Conditions

When the liquid pipe thermistor is short circuited or open.

Supposed Causes

- Faulty liquid pipe thermistor 1 (R6T), (R9T)
- Faulty outdoor unit PC board
- Defect of thermistor connection

J6

J7

Troubleshooting



Caution

Be sure to turn off power switch before connect or disconnect connector, or parts damage may be occurred.

Confirm which thermistor is abnormal using outdoor unit "monitor mode".
(Refer to P.42~45)

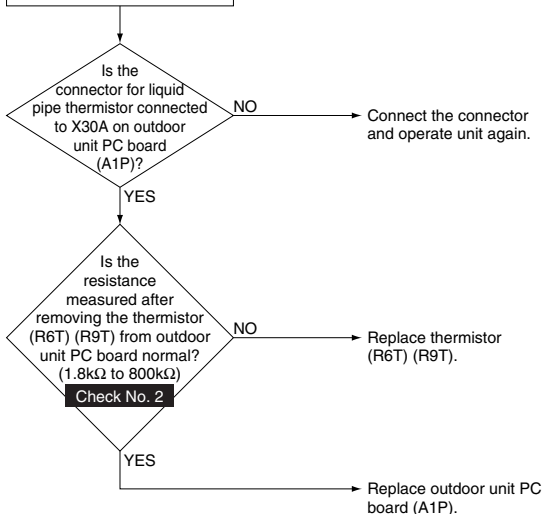

Refer to Check No. 2 on page 361.

(32) Malfunction of Oil Equalizing Pipe Thermistor (R7T)

Remote Controller Display

J8

Applicable Models

VRV II and III H/R Series

Method of Malfunction Detection

Malfunction is detected according to the temperature detected by oil equalizing pipe thermistor.

Malfunction Decision Conditions

When the oil equalizing pipe thermistor is short circuited or open.

Supposed Causes

- Faulty oil equalizing pipe thermistor (R7T)
- Faulty outdoor unit PC board

J7

J8

Troubleshooting



Caution

Be sure to turn off power switch before connect or disconnect connector, or parts damage may be occurred.

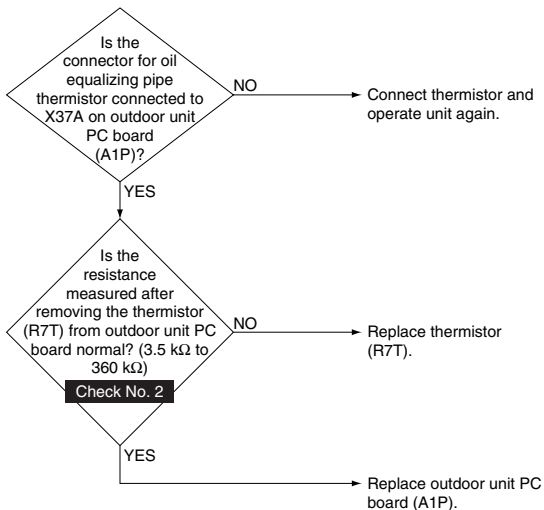

Refer to Check No. 2 on page 361.

(33) Malfunction of Receiver Gas Pipe Thermistor (R5T)

Remote Controller Display

J9

Applicable Models

All indoor unit models

Method of Malfunction Detection

Malfunction is detected according to the temperature detected by receiver gas pipe thermistor.

Malfunction Decision Conditions

When the receiver gas pipe thermistor is short circuited or open.

Supposed Causes

- Faulty receiver gas pipe thermistor (R5T)
- Faulty outdoor unit PC board

J8

J9

Troubleshooting



Caution

Be sure to turn off power switch before connect or disconnect connector, or parts damage may be occurred.

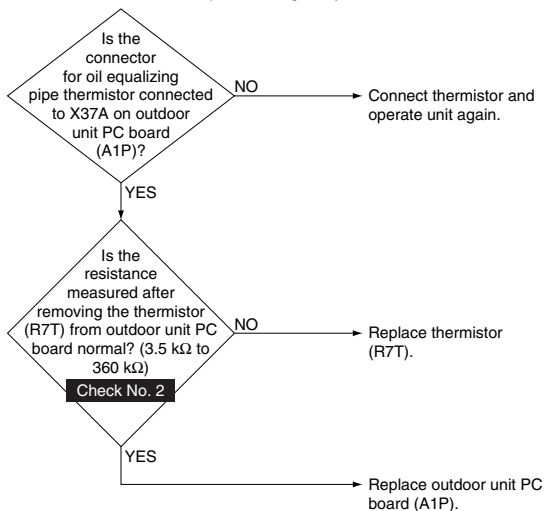

Refer to Check No. 2 on page 361.

(34) Malfunction of Discharge Pipe Pressure Sensor

Remote Controller Display

JR

Applicable Models

except VRV III H/R and C/O Series

Method of Malfunction Detection

Malfunction is detected from the pressure detected by the high pressure sensor.

Malfunction Decision Conditions

When the discharge pipe pressure sensor is short circuit or open circuit.

J9

Supposed Causes

- Defect of high pressure sensor system
- Connection of low pressure sensor with wrong connection.
- Defect of outdoor unit PC board.

JA

Troubleshooting



Caution

Be sure to turn off power switch before connect or disconnect connector, or parts damage may be occurred.

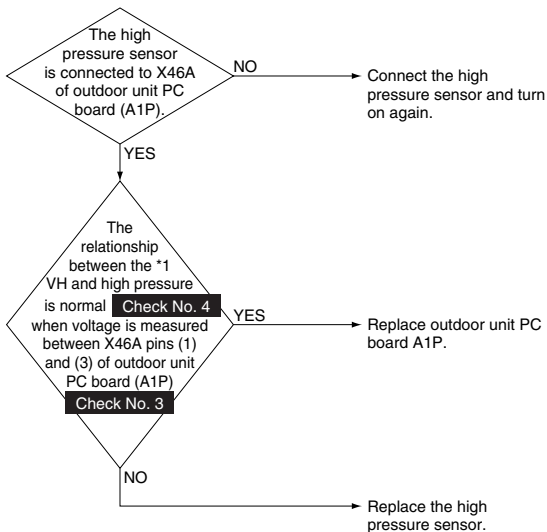

Refer to Check No. 3, 4 on page 365, 366.

Remote Controller Display

JA

Applicable Models

VRV III H/R and C/O Series

Method of Malfunction Detection

Malfunction is detected from the pressure detected by the high pressure sensor.

Malfunction Decision Conditions

When the high pressure sensor is short circuit or open circuit.

(Not less than 4.22MPa, or 0.01MPa and below)

Supposed Causes

- Defect of high pressure sensor system
- Connection of low pressure sensor with wrong connection.
- Defect of outdoor unit PC board.
- Defective connection of high pressure sensor

JA

Troubleshooting



Caution

Be sure to turn off power switch before connect or disconnect connector, or parts damage may be occurred.

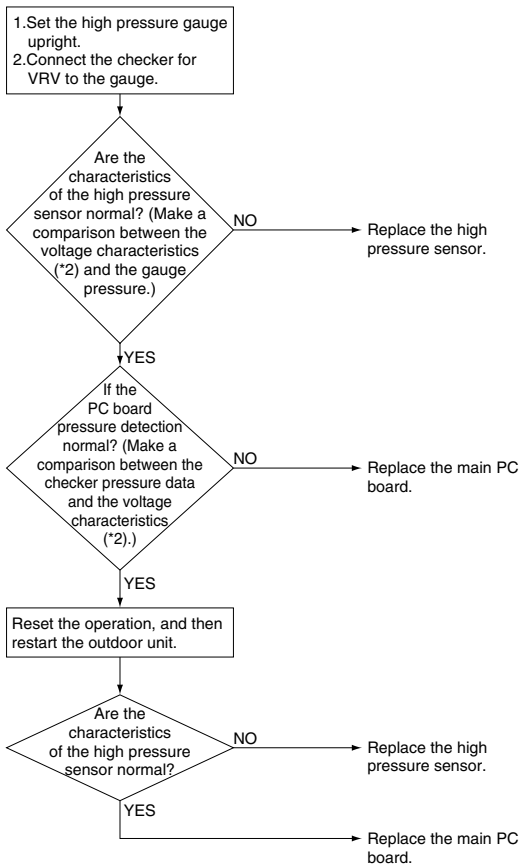

*1: Pressure sensor subject to malfunction code

Malfunction code	Pressure sensor subject to malfunction code	Electric symbol
JA	High pressure sensor	S1NPH

*2: **Check No.3** Measure the voltage of the pressure sensor.



Refer to Check No. 3, 4 on page 365, 366.

JA

(35) Malfunction of Suction Pipe Pressure Sensor

Remote Controller Display



Applicable Models

except VRV III H/R and C/O Series

Method of Malfunction Detection

Malfunction is detected from pressure detected by low pressure sensor.

Malfunction Decision Conditions

When the suction pipe pressure sensor is short circuit or open circuit.

Supposed Causes

- Defect of low pressure sensor system
- Connection of high pressure sensor with wrong connection.
- Defect of outdoor unit PC board.

Troubleshooting



Caution

Be sure to turn off power switch before connect or disconnect connector, or parts damage may be occurred.

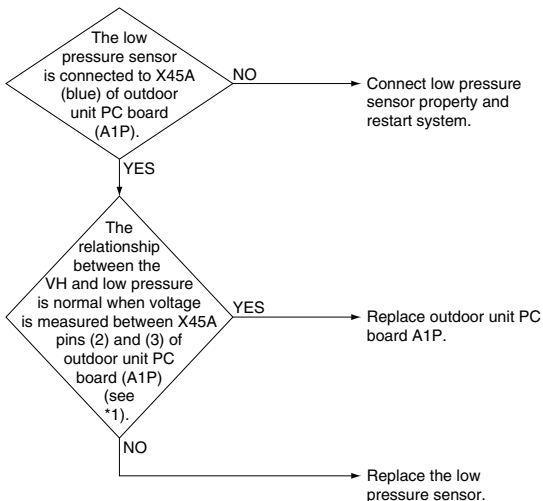

JC

*1: **Check No.3** , **Check No.4** Measure the voltage of the pressure sensor.



Refer to Check No. 3, 4 on page 365, 366.

Remote Controller Display



Applicable Models

VRV III H/R and C/O Series

Method of Malfunction Detection

Malfunction is detected from pressure detected by low pressure sensor.

Malfunction Decision Conditions

When the low pressure sensor is short circuit or open circuit.

(Not less than 1.77MPa, or -0.01MPa and below)

Supposed Causes

- Defect of low pressure sensor system
- Connection of high pressure sensor with wrong connection.
- Defect of outdoor unit PC board.
- Defective connection of low pressure sensor

Troubleshooting



Caution

Be sure to turn off power switch before connect or disconnect connector, or parts damage may be occurred.

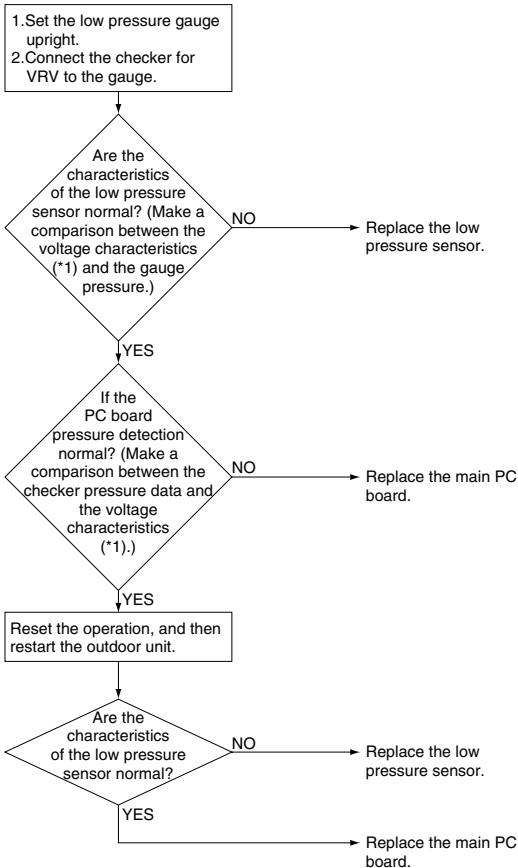

JC

*1: **Check No.3** , **Check No.4** Measure the voltage of the pressure sensor.



Refer to Check No. 3, 4 on page 365, 366.

(36) Defective Inverter PC Board

Remote Controller Display

L1

Applicable Models

VRV III H/R and C/O Series

Method of Malfunction Detection

Malfunction is detected based on the current value during waveform output before starting compressor.

Malfunction is detected based on the value from current sensor during synchronous operation when starting the unit.

Malfunction Decision Conditions

Overcurrent (OCP) flows during waveform output.

Malfunction of current sensor during synchronous operation.

IPM failure.

Supposed Causes

- Inverter PC board (A2P)
 - IPM failure
 - Current sensor failure
 - Drive circuit failure

Troubleshooting

Caution Be sure to turn off power switch before connect or disconnect connector, or parts damage may be occurred.

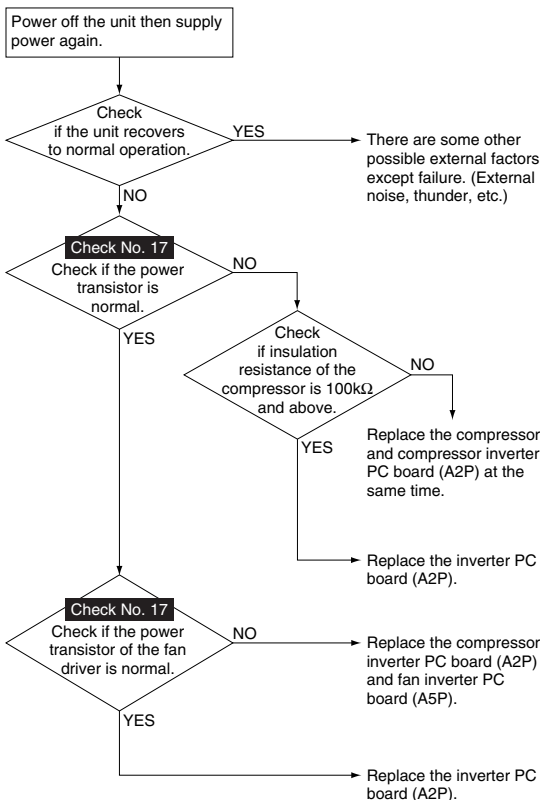

L1



Refer to Check No. 17 on page 391.

Remote Controller Display

L1

Applicable Models

VRV III-S Series

Method of Malfunction Detection

Detect malfunctions by current value during waveform output before compressor startup.

Detect malfunctions by current sensor value during synchronized operation at the time of startup.

Detect malfunctions using an SP-PAM series capacitor overvoltage sensor.

Malfunction Decision Conditions

In case of overcurrent (OCP) during waveform output

When the current sensor malfunctions during synchronized operation

When overvoltage occurs in SP-PAM

In case of IGBT malfunction

Supposed Causes

- Faulty outdoor PC board (A1P)
 - IPM failure
 - Current sensor failure
 - SP-PAM failure
 - Failure of IGBT or drive circuit

Troubleshooting

**Caution**

Be sure to turn off power switch before connect or disconnect connector, or parts damage may be occurred.

Turn OFF the power supply once and then turn it ON again.

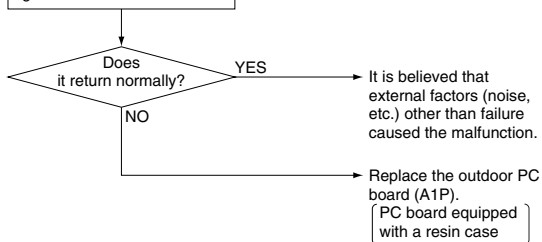
**L1**

(37) Malfunction of Inverter Radiating Fin Temperature Rise

Remote Controller Display

L4

Applicable Models

VRV II, II-S and WII Series

Method of Malfunction Detection

Fin temperature is detected by the thermistor of the radiation fin.

Malfunction Decision Conditions

When the temperature of the inverter radiation fin increases above 89°C.

Supposed Causes

- Actuation of fin thermal (Actuates above 89°C)
- Defect of inverter PC board
- Defect of fin thermistor

Troubleshooting



Caution

Be sure to turn off power switch before connect or disconnect connector, or parts damage may be occurred.

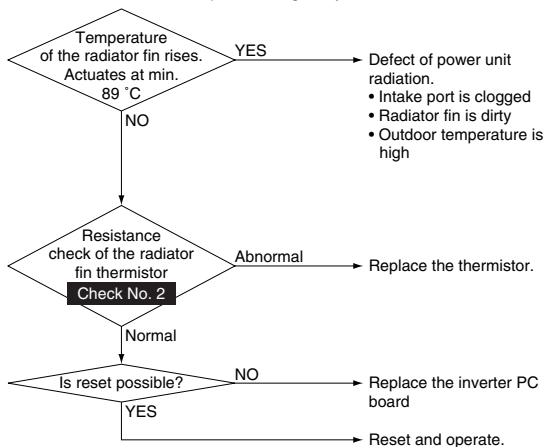

L4



Refer to Check No. 2 on page 361.

Remote Controller Display

L4

Applicable Models

VRV III Series

Method of Malfunction Detection

Fin temperature is detected by the thermistor of the radiation fin.

Malfunction Decision Conditions

When the temperature of the inverter radiation fin increases above 93°C.

Supposed Causes

- Actuation of fin thermal (Actuates above 93°C)
- Defect of inverter PC board
- Defect of fin thermistor

Troubleshooting



Caution

Be sure to turn off power switch before connect or disconnect connector, or parts damage may be occurred.

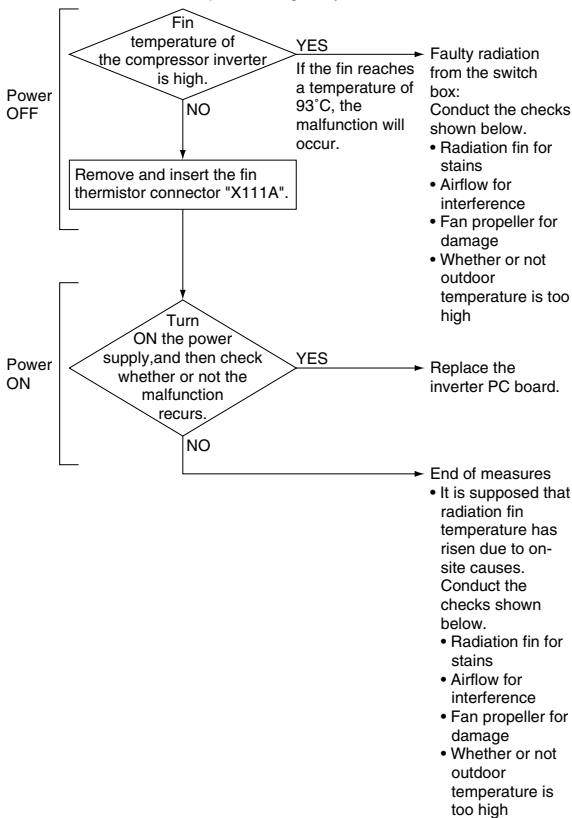

L4

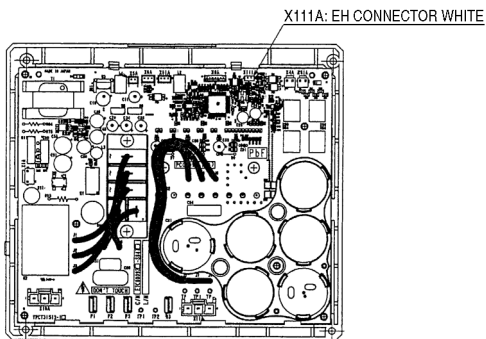

Inverter PC board for compressor



Refer to Check No. 2 on page 361.

Remote Controller Display

L4

Applicable Models

VRV III-S Series

Method of Malfunction Detection

Fin temperature is detected by the thermistor of the radiation fin.

Malfunction Decision Conditions

When the temperature of the inverter radiation fin increases above 83°C.

Supposed Causes

- Actuation of fin thermal (Actuates above 83°C)
- Defect of inverter PC board
- Defect of fin thermistor

L4

Troubleshooting



Caution

Be sure to turn off power switch before connect or disconnect connector, or parts damage may be occurred.

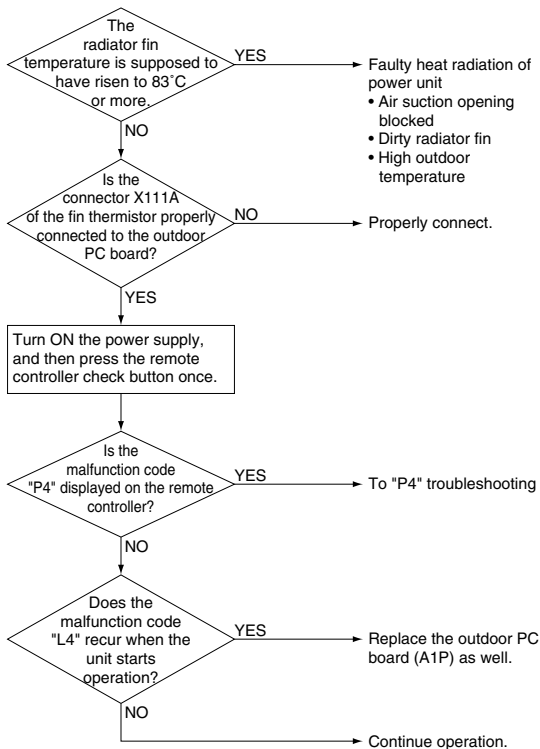

(38) Inverter Compressor Abnormal

Remote Controller Display

L5

Applicable Models

VRV II, II-S, WII and III-S Series

Method of Malfunction Detection

Malfunction is detected from current flowing in the power transistor.

Malfunction Decision Conditions

When an excessive current flows in the power transistor.
(Instantaneous overcurrent also causes activation.)

Supposed Causes

- Defect of compressor coil (disconnected, defective insulation)
- Compressor start-up malfunction (mechanical lock)
- Defect of inverter PC board

L4

L5

Troubleshooting

Compressor inspection



Caution

Be sure to turn off power switch before connect or disconnect connector, or parts damage may be occurred.

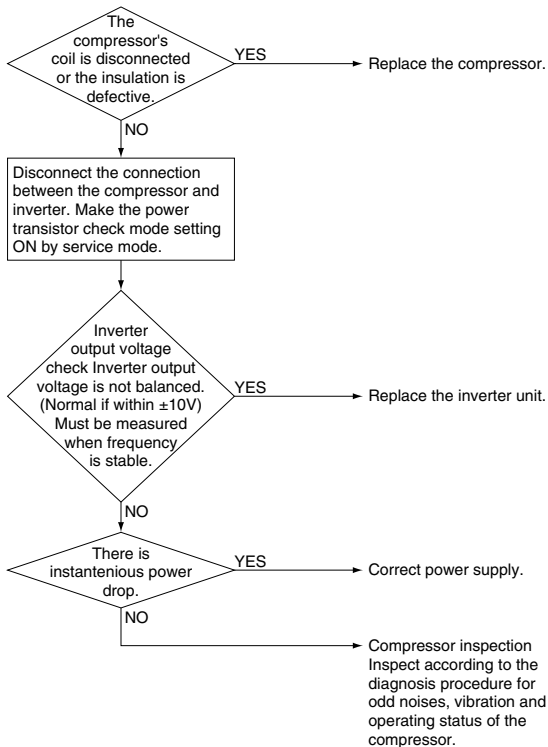

Higher voltage than actual is displayed when the inverter output voltage is checked by tester.

Remote Controller Display

L5

Applicable Models

VRV III H/P and C/O Series

Method of Malfunction Detection

Malfunction is detected from current flowing in the power transistor.

Malfunction Decision Conditions

When an excessive current flows in the power transistor.
(Instantaneous overcurrent also causes activation.)

Supposed Causes

- Defect of compressor coil (disconnected, defective insulation)
- Compressor start-up malfunction (mechanical lock)
- Defect of inverter PC board

L5

Troubleshooting

Compressor inspection



Caution

Be sure to turn off power switch before connect or disconnect connector, or parts damage may be occurred.

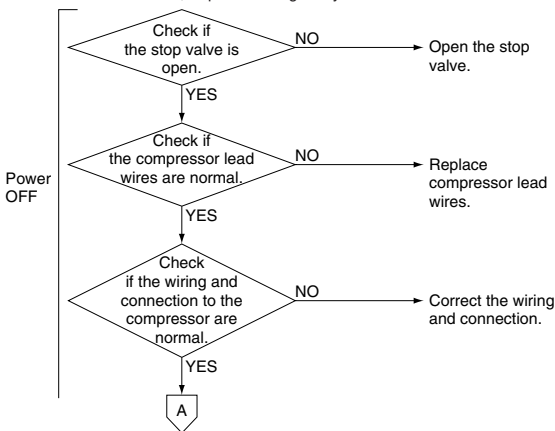



Caution

Be sure to turn off power switch before connect or disconnect connector, or parts damage may be occurred.

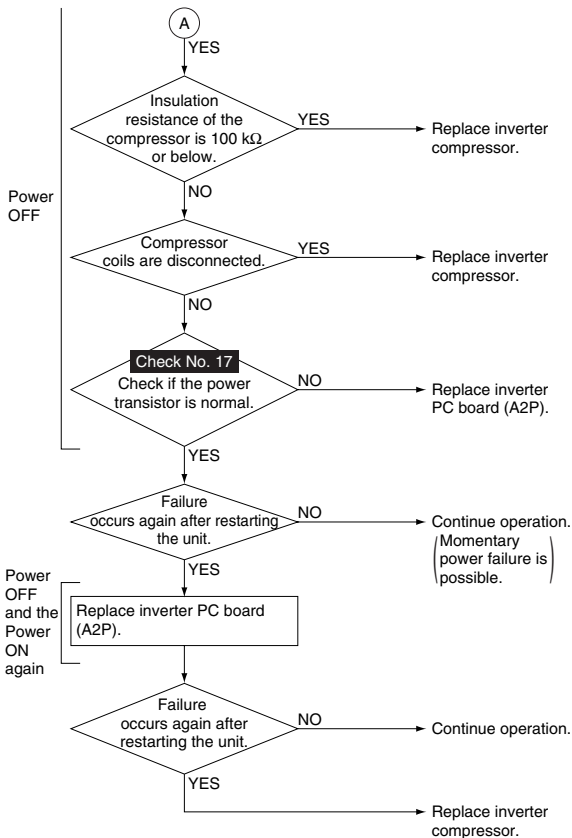

Refer to Check No. 17 on page 391.

Remote Controller Display

L5

Applicable Models

VRV III H/P Series

Method of Malfunction Detection

Malfunction is detected from current flowing in the power transistor.

Malfunction Decision Conditions

When an excessive current flows in the power transistor.
(Instantaneous overcurrent also causes activation.)

Supposed Causes

- Defect of compressor coil (disconnected, defective insulation)
- Compressor start-up malfunction (mechanical lock)
- Defect of inverter PC board

L5

Troubleshooting

Compressor inspection



Caution

Be sure to turn off power switch before connect or disconnect connector, or parts damage may be occurred.

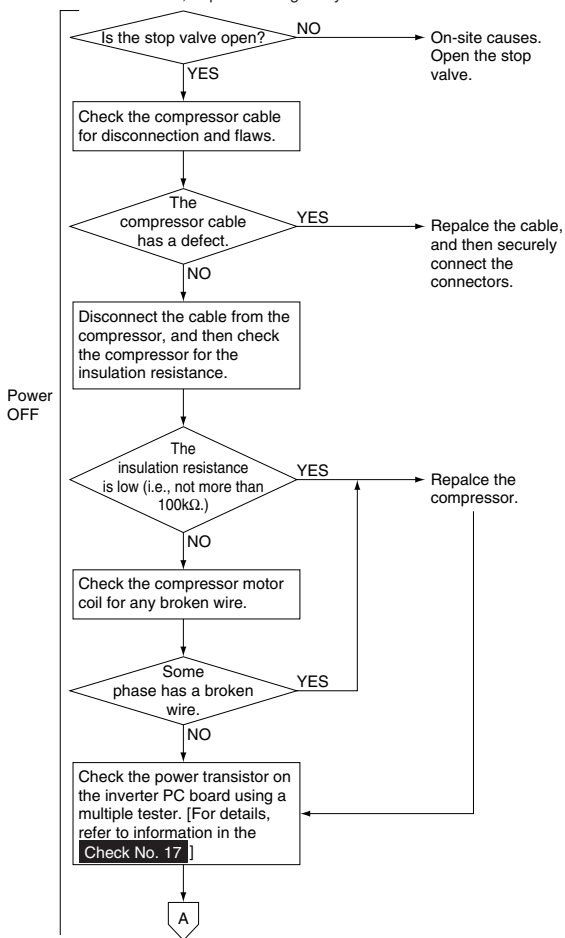

Refer to Check No. 17 on page 391.



Caution

Be sure to turn off power switch before connect or disconnect connector, or parts damage may be occurred.

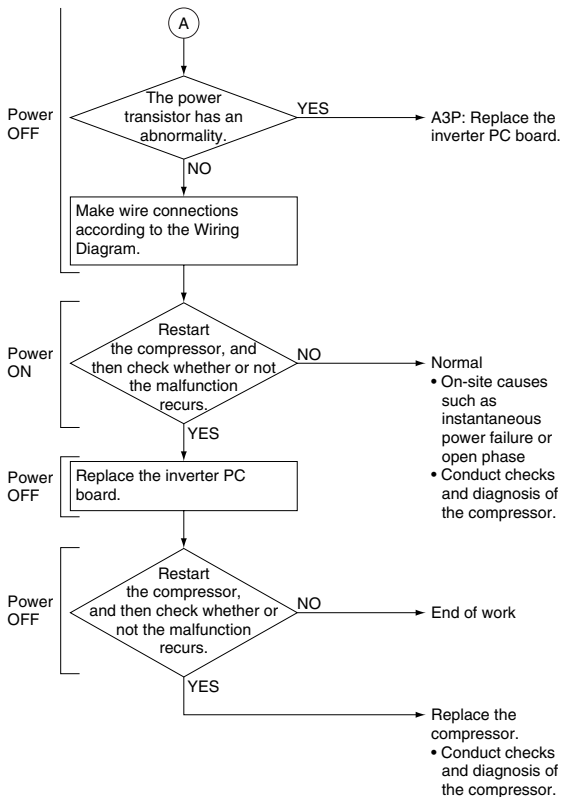

L5

(39) Inverter Current Abnormal

Remote Controller Display

L8

Applicable Models

VRV II, II-S, WII and III-S Series

Method of Malfunction Detection

Malfunction is detected by current flowing in the power transistor.

Malfunction Decision Conditions

When overload in the compressor is detected.

Supposed Causes

- Compressor overload
- Compressor coil disconnected
- Defect of inverter PC board

Troubleshooting

Output current check



Caution

Be sure to turn off power switch before connect or disconnect connector, or parts damage may be occurred.

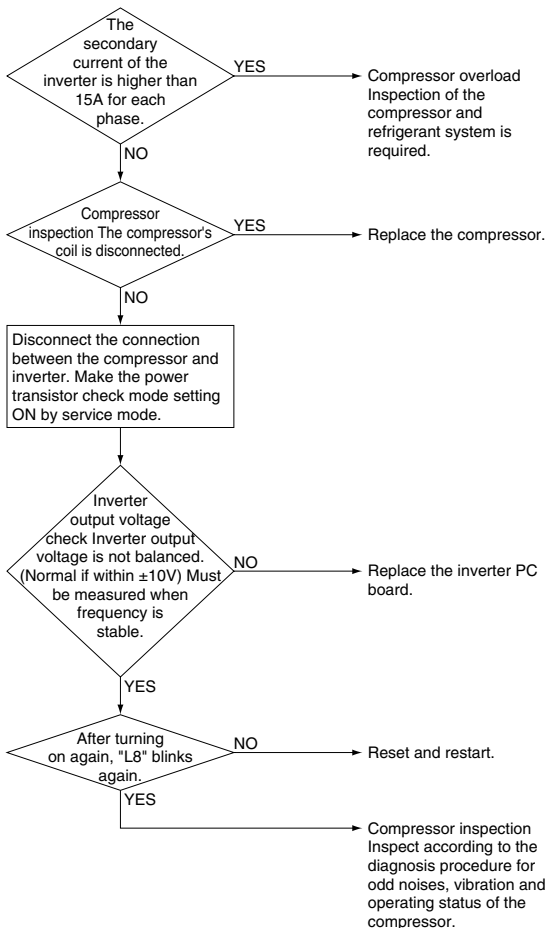

L8

Remote Controller Display

L8

Applicable Models

VRV III H/R and C/O Series

Method of Malfunction Detection

Malfunction is detected by current flowing in the power transistor.

Malfunction Decision Conditions

When overload in the compressor is detected. (Inverter secondary current 16.1A)

- (1) 33.5A and over continues for 5 seconds.
- (2) 27.6A and over continues for 260 seconds.

Supposed Causes

- Compressor overload
- Compressor coil disconnected
- Defect of inverter PC board
- Faulty compressor

Troubleshooting

Output current check



Caution

Be sure to turn off power switch before connect or disconnect connector, or parts damage may be occurred.

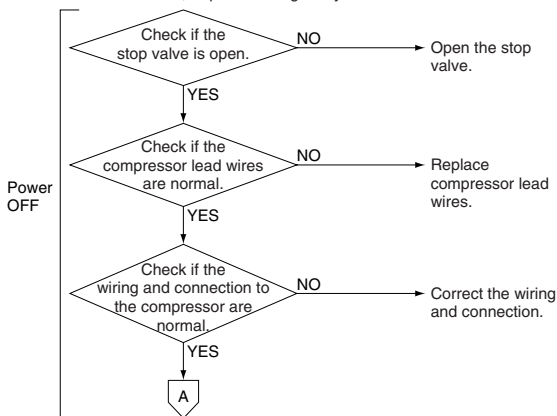



Caution

Be sure to turn off power switch before connect or disconnect connector, or parts damage may be occurred.

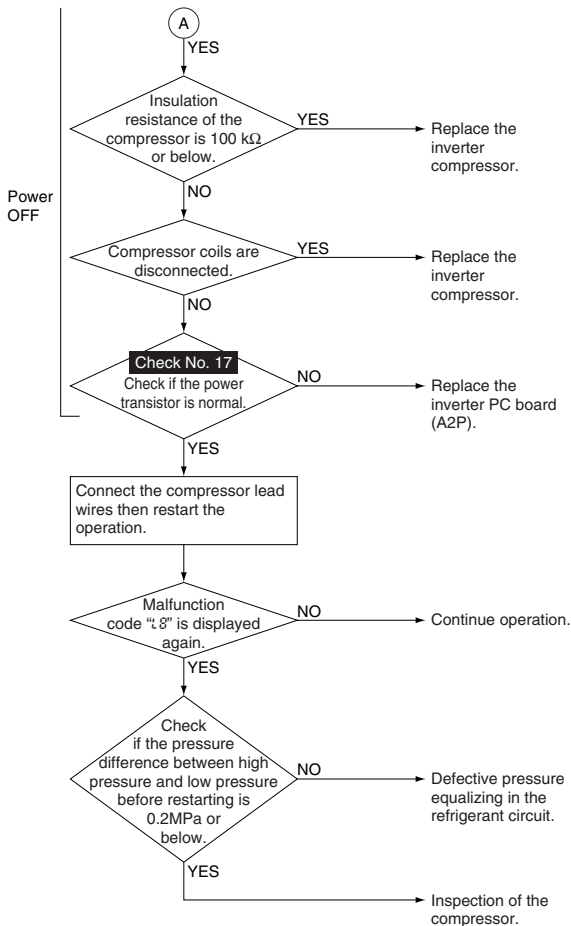

L8



Refer to Check No. 17 on page 391.

Remote Controller Display

L8

Applicable Models

VRV III Series

Method of Malfunction Detection

Malfunction is detected by current flowing in the power transistor.

Malfunction Decision Conditions

When overload in the compressor is detected. (Inverter secondary current 16.1A)

Supposed Causes

- Compressor overload
- Compressor coil disconnected
- Defect of inverter PC board
- Faulty compressor

Troubleshooting

Output current check



Caution

Be sure to turn off power switch before connect or disconnect connector, or parts damage may be occurred.

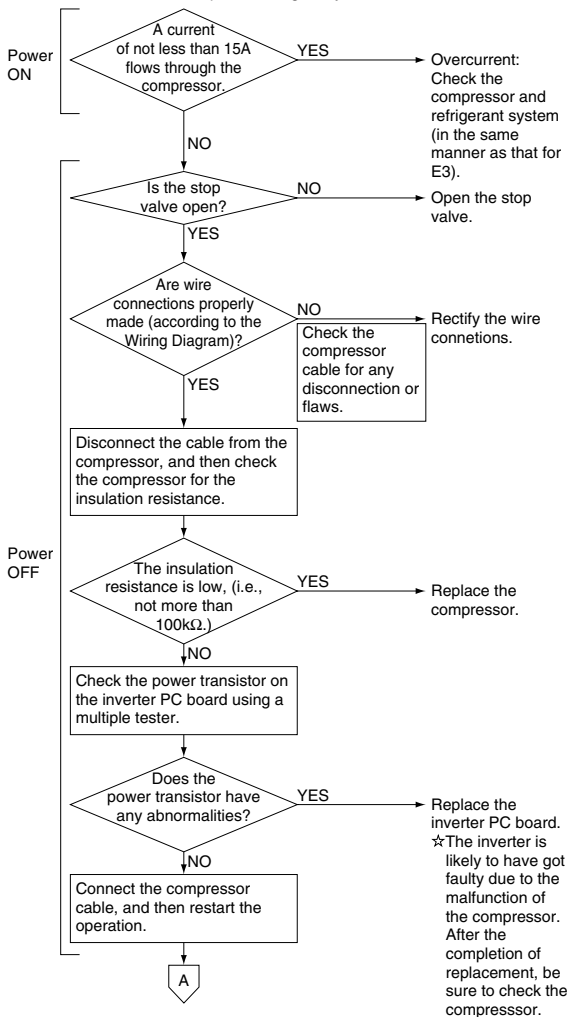

L8



Caution

Be sure to turn off power switch before connect or disconnect connector, or parts damage may be occurred.

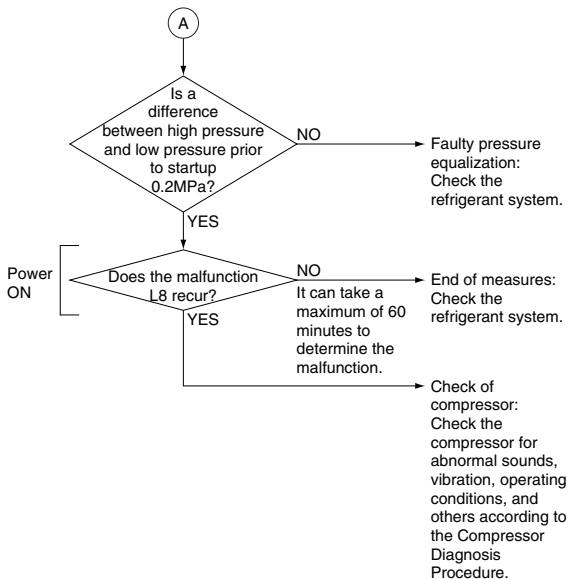

(40) Inverter Start up Error

Remote Controller Display

L9

Applicable Models

VRV II, II-S, WII and III-S Series

Method of Malfunction Detection

Malfunction is detected from current flowing in the power transistor.

Malfunction Decision Conditions

When overload in the compressor is detected during startup

Supposed Causes

- Defect of compressor
- Pressure differential start
- Defect of inverter PC board

L8

L9

Troubleshooting



Caution

Be sure to turn off power switch before connect or disconnect connector, or parts damage may be occurred.

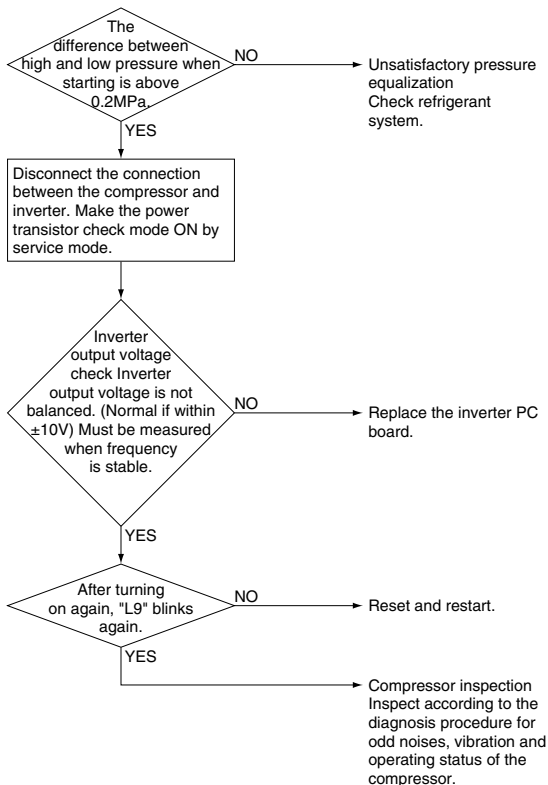

Remote Controller Display

L9

Applicable Models

VRV III H/P and C/O Series

Method of Malfunction Detection

Detect the failure based on the signal waveform of the compressor.

Malfunction Decision Conditions

Starting the compressor does not complete.

Supposed Causes

- Failure to open the stop valve
- Defective compressor
- Wiring connection error to the compressor
- Large pressure difference before starting the compressor
- Defective inverter PC board

L9

Troubleshooting



Caution

Be sure to turn off power switch before connect or disconnect connector, or parts damage may be occurred.

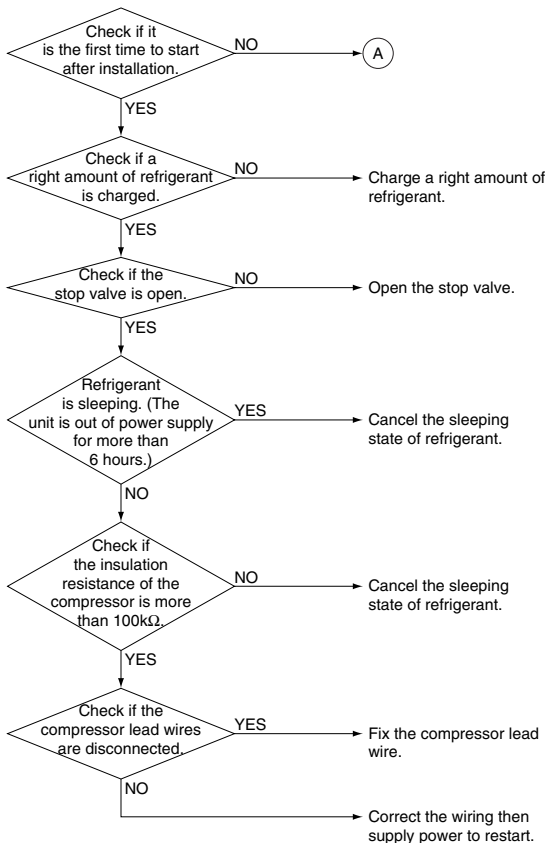

**Caution**

Be sure to turn off power switch before connect or disconnect connector, or parts damage may be occurred.

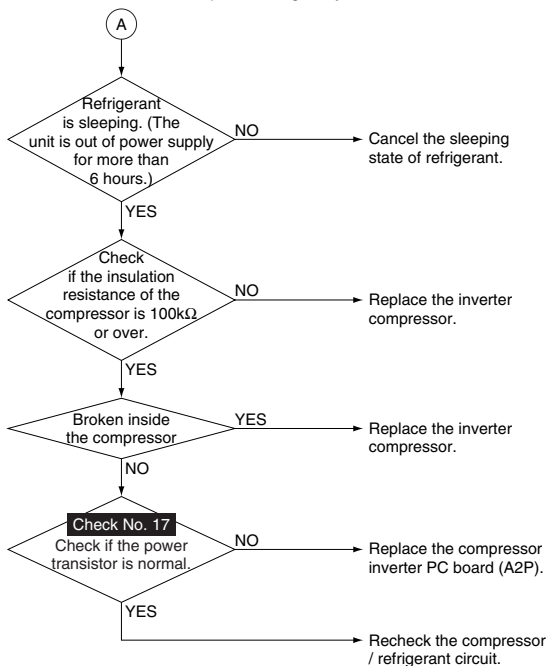
**L9**

Refer to Check No. 17 on page 391.

Remote Controller Display

L9

Applicable Models

VRV III H/P Series

Method of Malfunction Detection

This malfunction code will be output if overcurrent occurs at the time of startup.

Malfunction Decision Conditions

When the startup control is failed.

When an overcurrent is passed to the inverter due to the malfunction of a compressor or electrical system.

Supposed Causes

- Defect of compressor
- Failure to open the stop valve
- Pressure differential start
- Faulty compressor connection
- Defect of inverter PC board

Troubleshooting



Caution

Be sure to turn off power switch before connect or disconnect connector, or parts damage may be occurred.

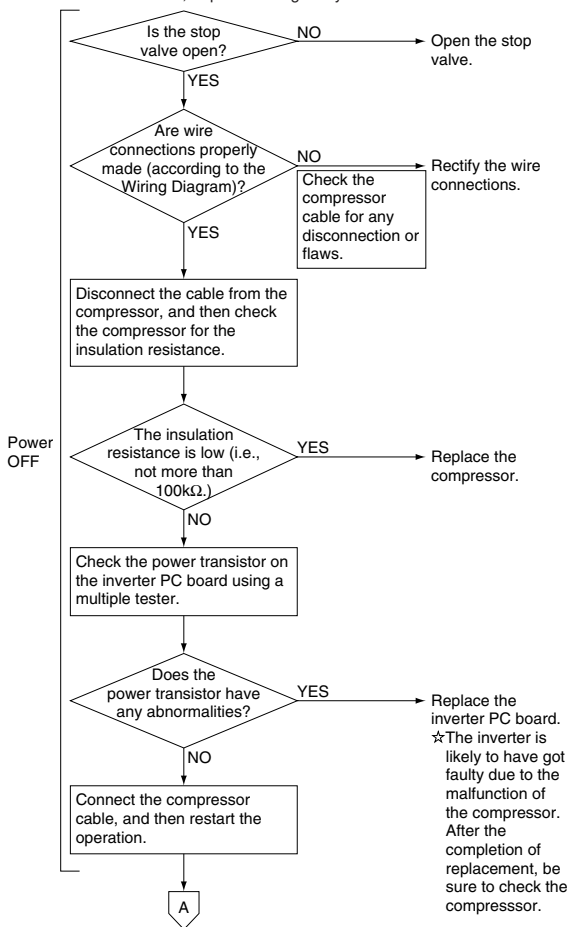

L9



Caution

Be sure to turn off power switch before connect or disconnect connector, or parts damage may be occurred.

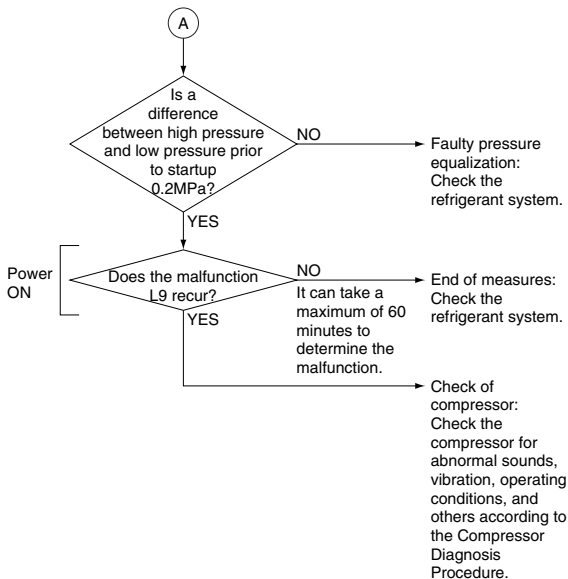

(41) Malfunction of Transmission Between Inverter and Control PC Board

Remote Controller Display

LC

Applicable Models

VRV II, II-S and WII Series

Method of Malfunction Detection

Check the communication state between inverter PC board and control PC board by microcomputer.

Malfunction Decision Conditions

When the correct communication is not conducted in certain period.

Supposed Causes

- Malfunction of connection between the inverter PC board and outdoor control PC board
- Defect of outdoor control PC board (transmission section)
- Defect of inverter PC board
- Defect of noise filter
- External factor (Noise etc.)

L9

LC

Troubleshooting



Caution

Be sure to turn off power switch before connect or disconnect connector, or parts damage may be occurred.

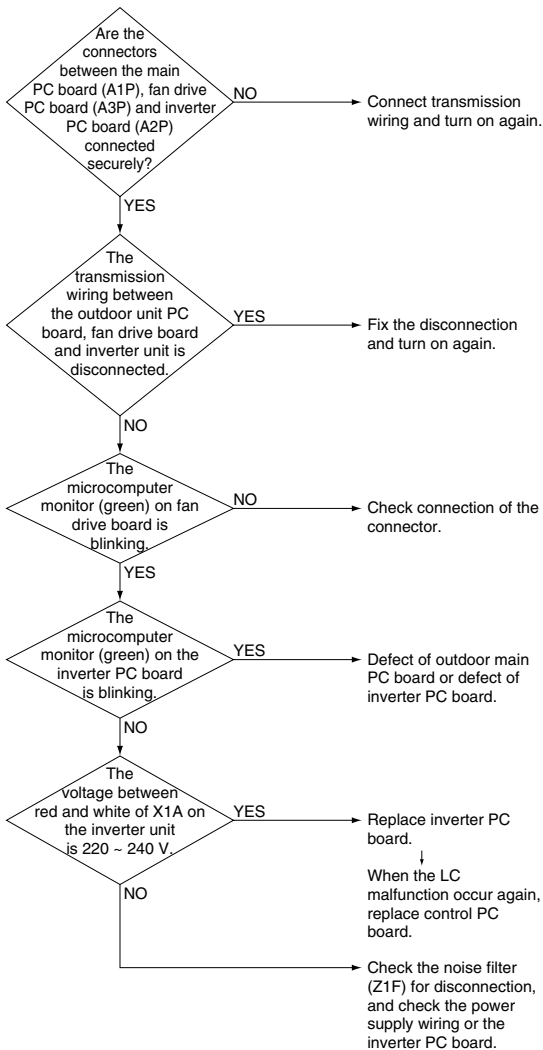

Remote Controller Display

LC

Applicable Models

VRV III Series

Method of Malfunction Detection

Check the communication state between inverter PC board and control PC board by microcomputer.

Malfunction Decision Conditions

When the correct communication is not conducted in certain period.

Supposed Causes

- Malfunction of connection between the inverter PC board and outdoor control PC board
- Defect of outdoor control PC board (transmission section)
- Defect of inverter PC board
- Defect of noise filter
- Faulty fan inverter
- Incorrect type of fan inverter
- Faulty compressor
- Faulty fan motor

LC

Troubleshooting



Caution

Be sure to turn off power switch before connect or disconnect connector, or parts damage may be occurred.

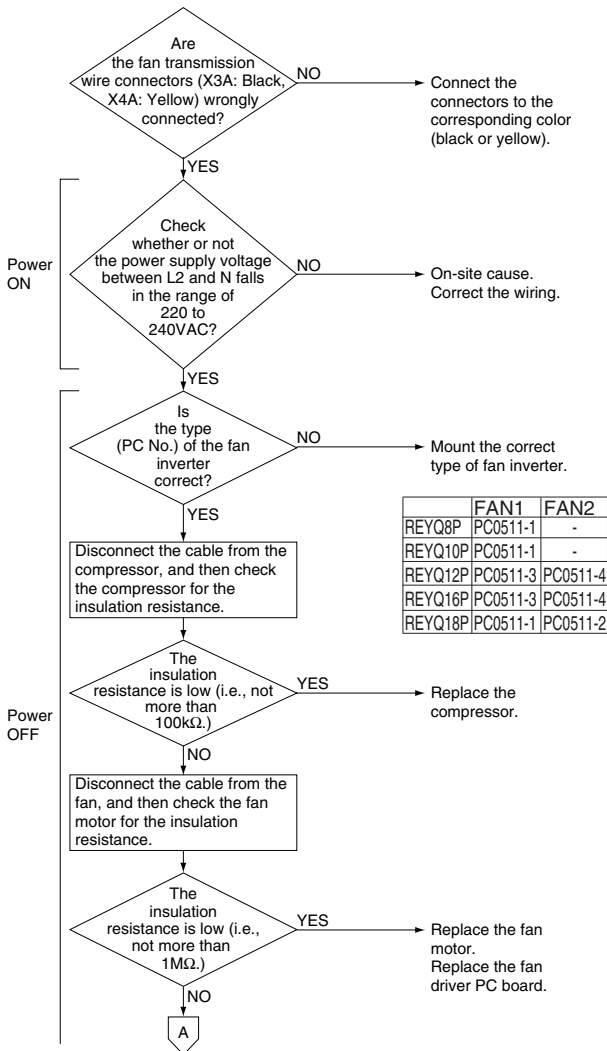

	FAN1	FAN2
REYQ8P	PC0511-1	-
REYQ10P	PC0511-1	-
REYQ12P	PC0511-3	PC0511-4
REYQ16P	PC0511-3	PC0511-4
REYQ18P	PC0511-1	PC0511-2



Caution

Be sure to turn off power switch before connect or disconnect connector, or parts damage may be occurred.

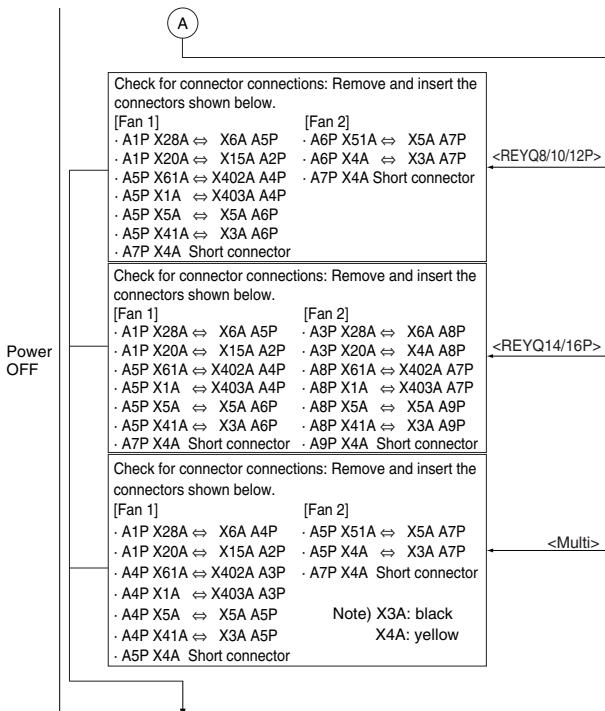

LC

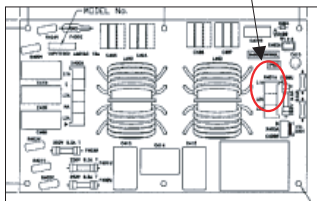
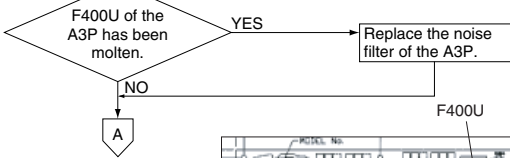



Caution

Be sure to turn off power switch before connect or disconnect connector, or parts damage may be occurred.

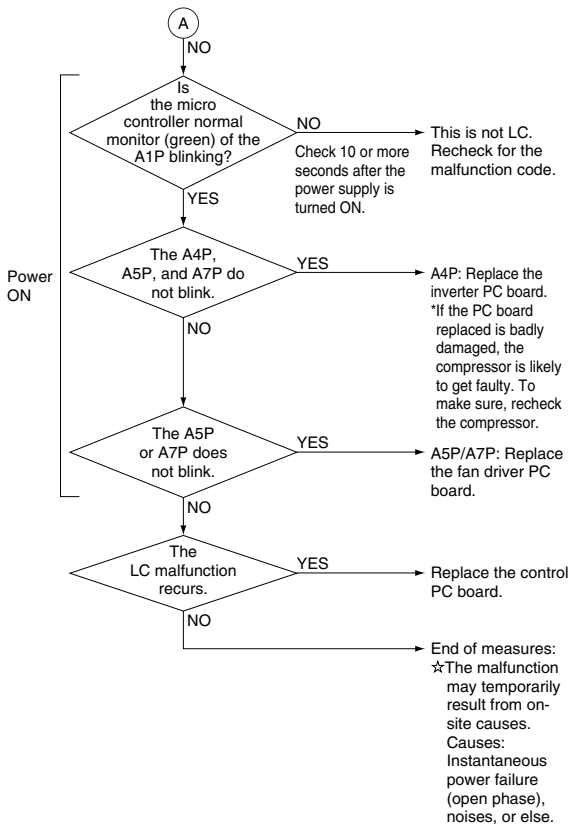

Remote Controller Display

LC

Applicable Models

VRV III-S 50/60Hz Series

Method of Malfunction Detection

Check the communication state between inverter PC board and control PC board by microcomputer.

Malfunction Decision Conditions

When the correct communication is not conducted in certain period.

Supposed Causes

- Malfunction of connection between the inverter microcomputer and outdoor control microcomputer
- Defect of outdoor unit PC board
- Defect of noise filter
- External factor (Noise etc.)

LC

Troubleshooting



Caution

Be sure to turn off power switch before connect or disconnect connector, or parts damage may be occurred.

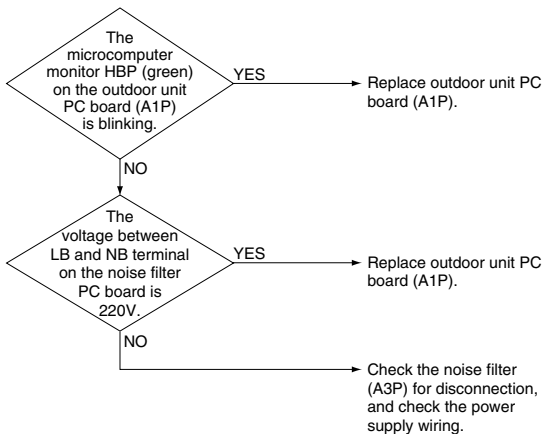

Remote Controller Display

LC

Applicable Models

VRV III-S 50Hz Series

Method of Malfunction Detection

Check the communication state between inverter PC board and control PC board by microcomputer.

Malfunction Decision Conditions

When the correct communication is not conducted in certain period.

Supposed Causes

- Malfunction of connection between the inverter microcomputer and outdoor control microcomputer
- Defect of outdoor unit PC board (A1P)
- External factor (Noise etc.)

LC

Troubleshooting

Caution

Be sure to turn off power switch before connect or disconnect connector, or parts damage may be occurred.

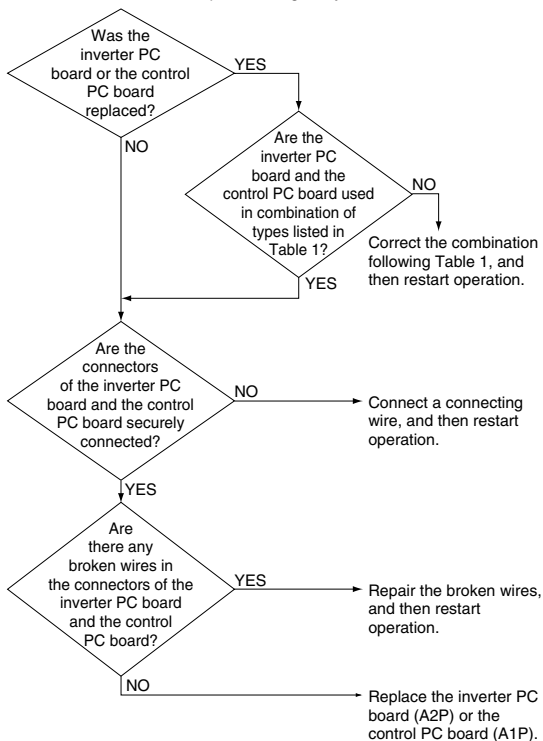

Table 1 : Combination of PC boards

	Type of control PC board	Type of inverter PC board
RXYSQ4P7Y1B RXYSQ5P7Y1B RXYSQ6P7Y1B	EC0640-1	PC0625-1
RXYSQ4P7Y1BH RXYSQ5P7Y1BH RXYSQ6P7Y1BH	EC0640-2	PC0625-2

(42) Inverter Over-Ripple Protection

Remote Controller Display

P1

Applicable Models

VRV II, WII and III Series

Method of Malfunction Detection

Imbalance in supply voltage is detected in PC board.

Malfunction Decision Conditions

When the resistance value of thermistor becomes a value equivalent to open or short circuited status.

- Malfunction is not decided while the unit operation is continued.

"P1" will be displayed by pressing the inspection button.

LC

P1

Supposed Causes

- Open phase
- Voltage imbalance between phases
- Defect of main circuit capacitor
- Defect of inverter PC board
- Defect of K1M
- Improper main circuit wiring

Troubleshooting



Caution

Be sure to turn off power switch before connect or disconnect connector, or parts damage may be occurred.

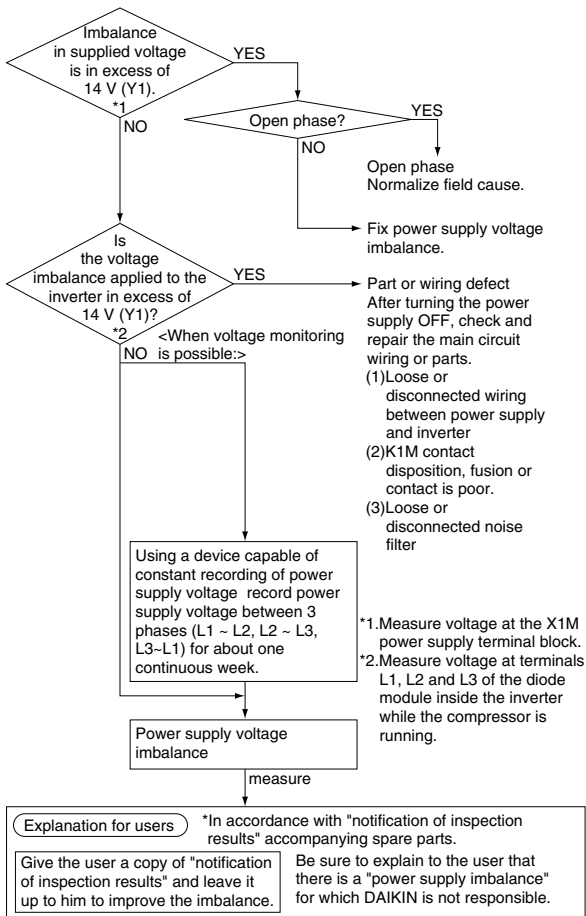

Remote Controller Display

P1

Applicable Models

VRV III-S 50/60Hz Series

Method of Malfunction Detection

Malfunction is detected according to the voltage waveform of main circuit capacitor built in the inverter.

Malfunction Decision Conditions

When the aforementioned voltage waveform becomes identical with the waveform of the power supply open phase.

Supposed Causes

- Defect of main circuit capacitor
- Improper main circuit wiring
- Defect of outdoor unit PC board (A1P)

P1

Troubleshooting



Caution

Be sure to turn off power switch before connect or disconnect connector, or parts damage may be occurred.

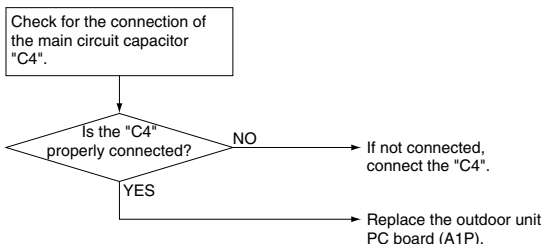

Remote Controller Display

P1

Applicable Models

VRV III-S 50Hz Series

Method of Malfunction Detection

Malfunction is detected according to the voltage waveform of main circuit capacitor built in the inverter.

Malfunction Decision Conditions

When the aforementioned voltage waveform becomes identical with the waveform of the power supply open phase.

Supposed Causes

- Defect of main circuit capacitor
- Improper main circuit wiring
- Defect of outdoor unit PC board (A2P)
- Imbalance of phase-to-phase voltages
- Open phase

Troubleshooting

**Caution**

Be sure to turn off power switch before connect or disconnect connector, or parts damage may be occurred.

Make measurement of power supply voltages between L1 and L2, L1 and L3, and L2 and L3.

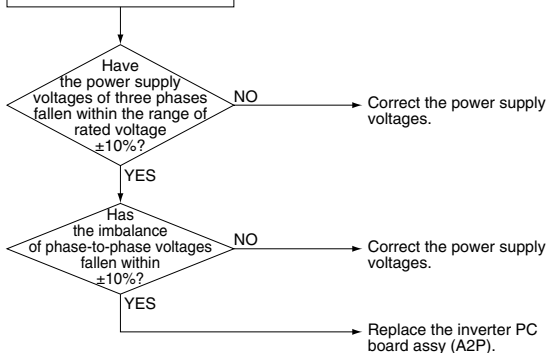
**P1**

(43) Malfunction of Inverter Radiating Fin Temperature Rise Sensor

Remote Controller Display

P4

Applicable Models

VRV II, II-S and WII Series

Method of Malfunction Detection

Resistance of radiation fin thermistor is detected when the compressor is not operating.

Malfunction Decision Conditions

When the resistance value of thermistor becomes a value equivalent to open or short circuited status.

- Malfunction is not decided while the unit operation is continued.

"P4" will be displayed by pressing the inspection button.

Supposed Causes

- Defect of radiator fin temperature sensor
- Defect of inverter PC board

Troubleshooting



Caution

Be sure to turn off power switch before connect or disconnect connector, or parts damage may be occurred.

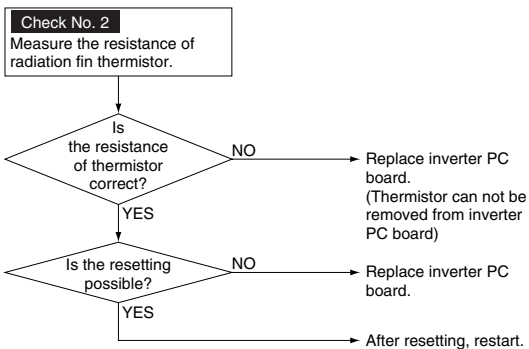

P4



Refer to Check No. 2 on page 361.

Remote Controller Display

P4

Applicable Models

VRV III Series

Method of Malfunction Detection

Resistance of radiation fin thermistor is detected when the compressor is not operating.

Malfunction Decision Conditions

When the resistance value of thermistor becomes a value equivalent to open or short circuited status.

- Malfunction is not decided while the unit operation is continued.
"P4" will be displayed by pressing the inspection button.

Supposed Causes

- Defect of radiator fin temperature sensor
- Defect of inverter PC board

Troubleshooting



Caution

Be sure to turn off power switch before connect or disconnect connector, or parts damage may be occurred.

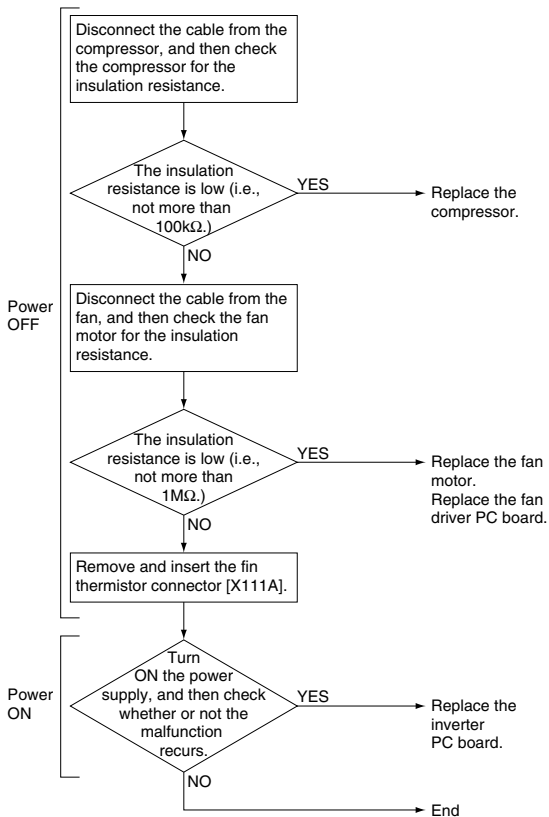

P4

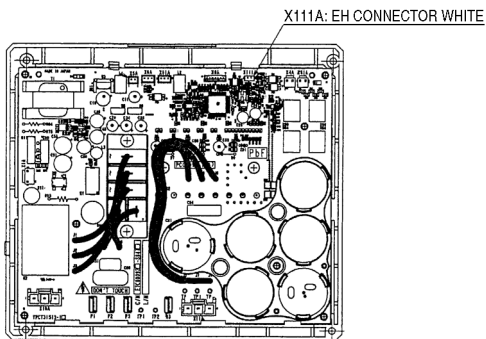

Inverter PC board for compressor



Refer to Check No. 2 on page 361.

Remote Controller Display

P4

Applicable Models

VRV III-S 50/60Hz Series

Method of Malfunction Detection

Resistance of radiation fin thermistor is detected when the compressor is not operating.

Malfunction Decision Conditions

When the resistance value of thermistor becomes a value equivalent to open or short circuited status.

- Malfunction is not decided while the unit operation is continued.

"P4" will be displayed by pressing the inspection button.

P4

Supposed Causes

- Defect of radiator fin temperature sensor
- Defect of outdoor unit PC board (A1P)

Troubleshooting



Caution

Be sure to turn off power switch before connect or disconnect connector, or parts damage may be occurred.

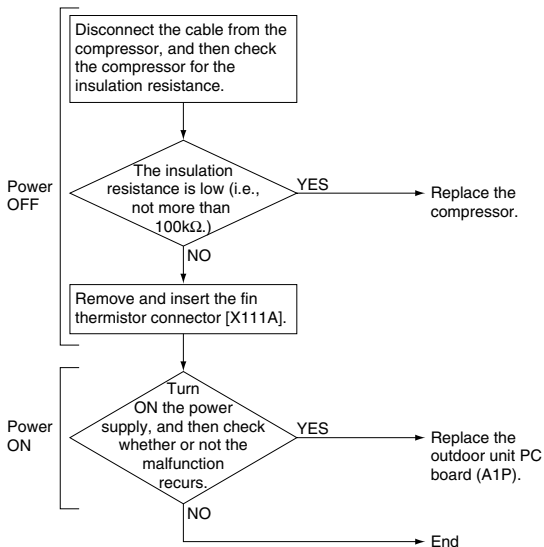

(44) Faulty Field Setting after Replacing Main PC Board or Faulty Combination of PC Board

Remote Controller Display

PJ

Applicable Models

VRV III Series

Method of Malfunction Detection

The faulty (or no) field setting after replacing main PC board or faulty PC board combination is detected through communications with the inverter.

Malfunction Decision Conditions

Whether or not the field setting or the type of the PC board is correct through the communication date is judged.

Supposed Causes

- Faulty (or no) field setting after replacing main PC board
- Mismatching of type of PC board

P4

PJ

Troubleshooting



Caution

Be sure to turn off power switch before connect or disconnect connector, or parts damage may be occurred.

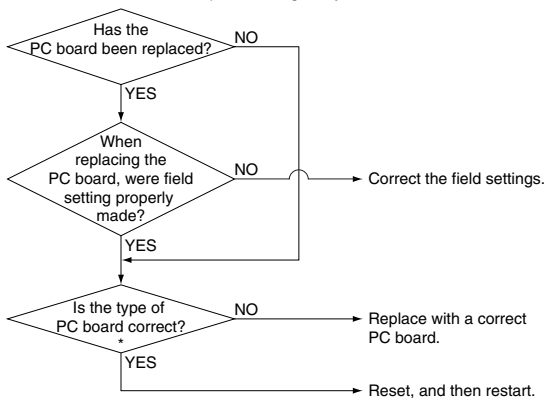

*Note) Type of PC board mismatching includes;
 Main PC board
 Inverter PC board (for compressor)
 Fan driver PC board

Remote Controller Display

PJ

Applicable Models

VRV II-S Series

Method of Malfunction Detection

Check the communication state between inverter PC board and control PC board by microcomputer.

Malfunction Decision Conditions

When the communication data about inverter PC board type is incorrect.

Supposed Causes

- Mismatching of inverter PC board
- Faulty field setting

PJ

Troubleshooting



Caution

Be sure to turn off power switch before connect or disconnect connector, or parts damage may be occurred.

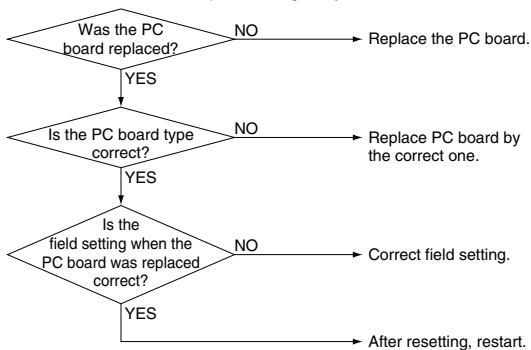

★ Refer to “Field Setting from Outdoor Unit” on applicable service manual.

(45) Low Pressure drop Due to Refrigerant Shortage or Electronic Expansion Valve Failure

Remote Controller Display

U0

Applicable Models

VRV II, II-S, III and III-S Series

Method of Malfunction Detection

Short of gas malfunction is detected by discharge pipe temperature thermistor.

Malfunction Decision Conditions

Microcomputer judge and detect if the system is short of refrigerant.

- Malfunction is not decided while the unit operation is continued.

Supposed Causes

- Out of gas or refrigerant system clogging (incorrect piping)
- Defect of pressure sensor
- Defect of outdoor unit PC board (A1P)
- Defect of thermistor R2T or R4T

PJ

U0

Troubleshooting



Caution

Be sure to turn off power switch before connect or disconnect connector, or parts damage may be occurred.

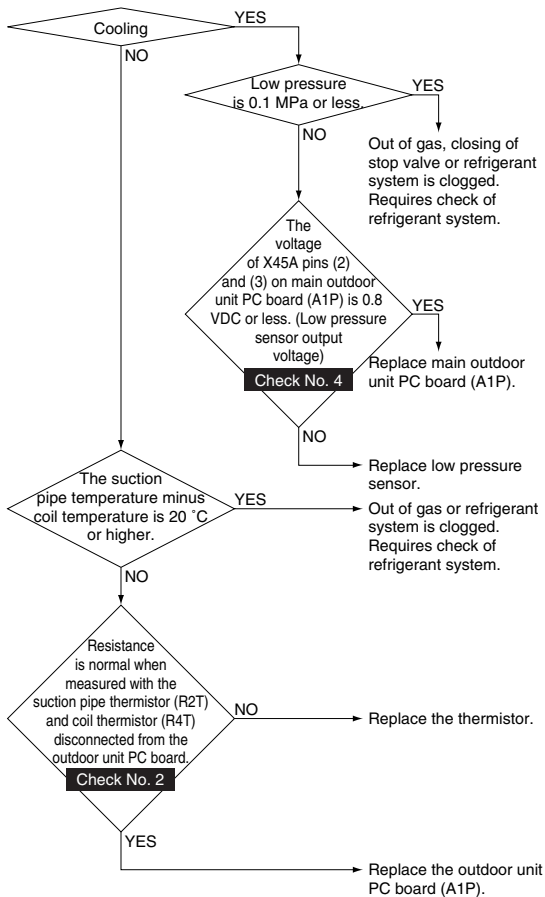

Refer to Check No. 2, 4 on page 361, 366.

Remote Controller Display

U0

Applicable Models

VRV III H/R and C/O Series

Method of Malfunction Detection

Detect gas shortage based on the temperature difference between low pressure or suction pipe and heat exchanger.

Malfunction Decision Conditions

[In cooling mode]

Low pressure becomes 0.1MPa or below.

[In heating mode]

The degree of superheat of suction gas becomes 20 degrees and over.

$SH = Ts1 - Te$

Ts1: Suction pipe temperature detected by thermistor

Te: Saturated temperature corresponding to low pressure

- Malfunction is not determined. The unit continues operation.

Supposed Causes

- Gas shortage or refrigerant clogging (piping error)
- Defective thermistor (R4T, R7T)
- Defective low pressure sensor
- Defective outdoor unit PC board (A1P)

U0

Troubleshooting



Caution

Be sure to turn off power switch before connect or disconnect connector, or parts damage may be occurred.

In cooling mode

- ① Set up a pressure gauge at the service port on the low pressure side.
- ② Reset the operation using the remote controller then restart.

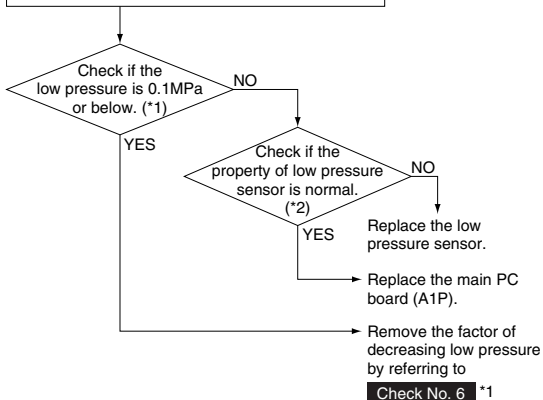

*1: Check the low pressure value by using pressure gauge in operation.

*2: Compare the actual measurement value by pressure sensor with the value by the pressure gauge. (To gain actual measurement value by pressure sensor, measure the voltage at the connector [between (2)-(3)] and then convert the value into pressure referring to **Check No.4** .)



Refer to Check No. 4, 6 on page 366, 371.

**Caution**

Be sure to turn off power switch before connect or disconnect connector, or parts damage may be occurred.

In heating mode

Reset the operation using the remote controller then restart.

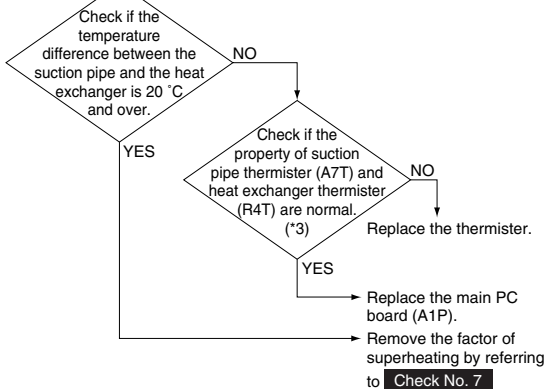
**U0**

*3: Compare the thermister resistance value with the value on the surface thermometer.



Refer to Check No. 6, 7 on page 371, 375.

Remote Controller Display

U0

Applicable Models

VRV WII Series

Method of Malfunction Detection

Detect insufficient gas using low pressure or difference in temperature between the suction pipe and the heat exchanger.

Malfunction Decision Conditions

In cooling

- Low pressure of 0.25 MPa or less continues for 30 minutes

In heating

- Suction gas superheated degree of 20°C or more continues for 60 minutes.

* Abnormality is not confirmed and operation is continued.

Supposed Causes

- Insufficient gas or clogged refrigerant (wrong piping)
- Faulty thermistor (R2T, R4T)
- Faulty low pressure sensor
- Faulty main PC board (A1P)

Troubleshooting



Caution

Be sure to turn off power switch before connect or disconnect connector, or parts damage may be occurred.

In cooling

- ① Set up a pressure gauge in the service port on the low pressure side.
- ② Connect the Service Checker.
- ③ Reset operation with a remote controller and restart operation.

Are the low pressure sensor characteristics normal? (*1)

NO

Replace the low pressure sensor.

YES

Is the PC board detector pressure normal? (*2)

NO

Replace the main PC board.

YES

Check No. 6 :
Eliminate the causes of low pressure drop.

U0

- *1 : Compare pressure sensor measurements with pressure gauge readings.
(For measurements by a pressure sensor, measure voltage between connectors (2) and (3) and convert it to pressure in accordance with **Check No.4** .)
- *2 : Compare low pressure measured by the Service Checker with pressure sensor measurements (refer to *1).



Refer to Check No. 4, 6 on page 366, 371.



Caution

Be sure to turn off power switch before connect or disconnect connector, or parts damage may be occurred.

In heating

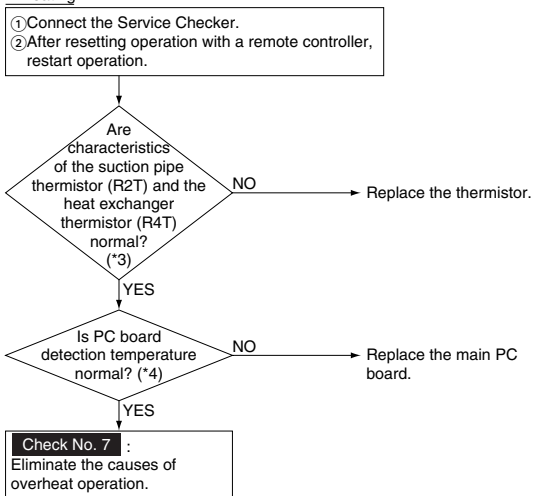

*3 : Compare the thermistor resistance with surface thermostat measurements.

*4 : Compare the suction pipe temperature checked by the Service Checker with measurements obtained in *3 above.



Refer to Check No. 7 on page 375.

Remote Controller Display

U0

Applicable Models

VRV III-S Series

Method of Malfunction Detection

Short of gas malfunction is detected by discharge pipe temperature thermistor and low pressure saturation temperature.

Malfunction Decision Conditions

Microcomputer judge and detect if the system is short of refrigerant.

- Malfunction is not decided while the unit operation is continued.

U0

Supposed Causes

- Out of gas or refrigerant system clogging (incorrect piping)
- Defect of pressure sensor
- Defect of outdoor unit PC board (A1P)
- Defect of thermistor R3T

Troubleshooting



Caution

Be sure to turn off power switch before connect or disconnect connector, or parts damage may be occurred.

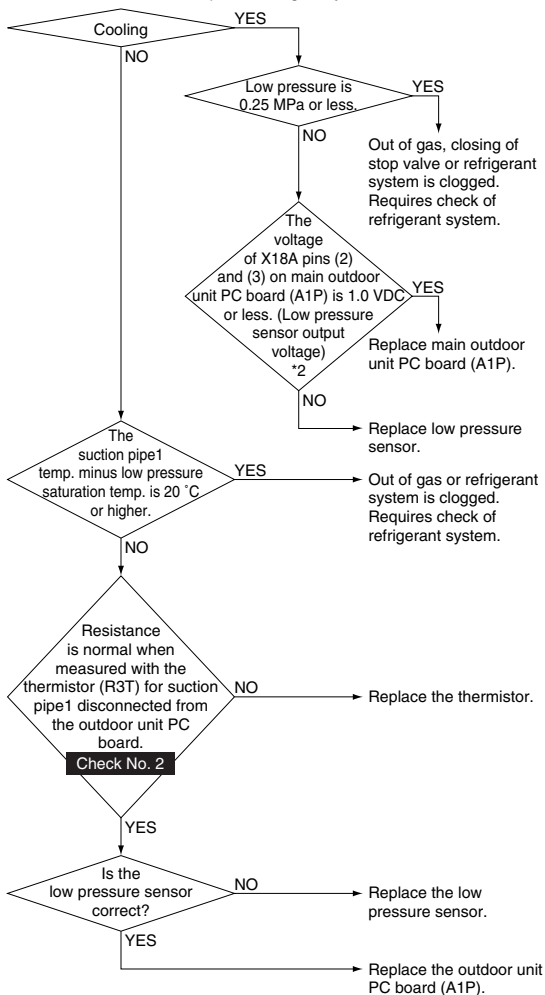

*2: **Check No.3** , **Check No.4** Measure the voltage of the pressure sensor.



Refer to Check No. 2~4 on page 361~366.

U0

(46) Reverse Phase, Open Phase

Remote Controller Display

U1

Applicable Models

VRV II, WII and III Series

Method of Malfunction Detection

Detection is based on the voltage in main circuit capacitor for inverter and supply voltage.

The phase of each phase are detected by reverse phase detection circuit and right phase or reverse phase are judged.

Supposed Causes

- Power supply reverse phase
- Power supply open phase
- Defect of outdoor PC board A1P

Troubleshooting



Caution

Be sure to turn off power switch before connect or disconnect connector, or parts damage may be occurred.

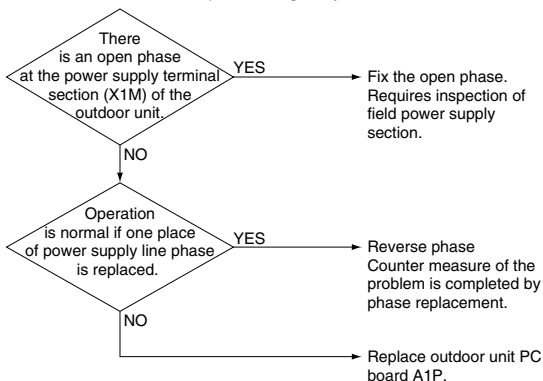

(47) Power Supply Insufficient or Instantaneous Failure

Remote Controller Display

U2

Applicable Models

VRV II and WII Series

Method of Malfunction Detection

Detection of voltage of main circuit capacitor built in the inverter and power supply voltage.

Supposed Causes

- Power supply insufficient
- Instantaneous failure
- Open phase
- Defect of inverter PC board
- Defect of outdoor control PC board
- Defect of K1M.
- Main circuit wiring defect

U1

U2

Troubleshooting



Caution

Be sure to turn off power switch before connect or disconnect connector, or parts damage may be occurred.

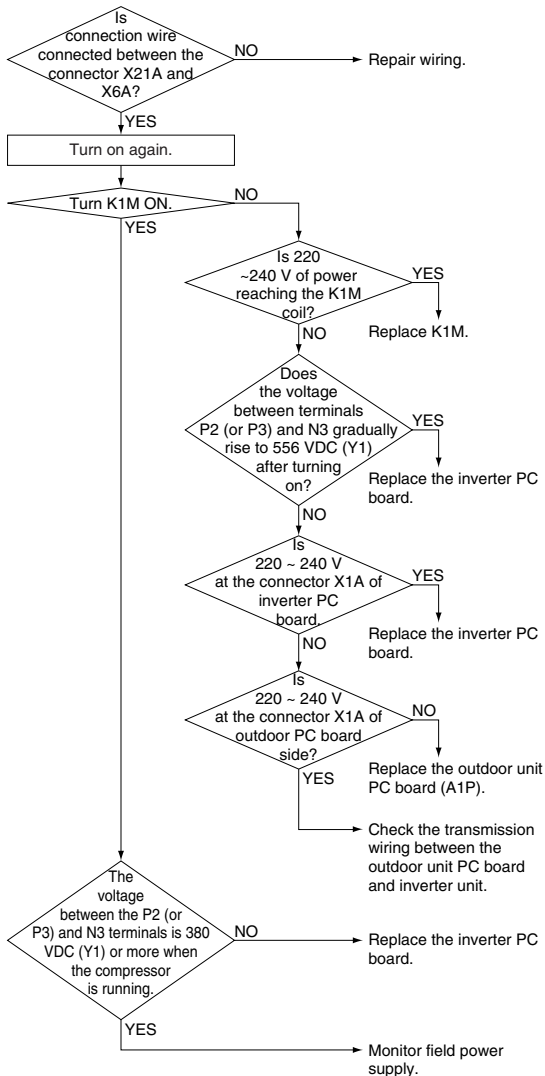

Remote Controller Display

U2

Applicable Models

VRV III Series

Method of Malfunction Detection

Detection of voltage of main circuit capacitor built in the inverter and power supply voltage.

Malfunction Decision Conditions

When the voltage aforementioned is not less than 780V or not more than 320V, or when the current-limiting voltage does not reach 200V or more or exceeds 740V.

Supposed Causes

- Power supply insufficient
- Instantaneous power failure
- Open phase
- Defect of inverter PC board
- Defect of outdoor control PC board
- Main circuit wiring defect
- Faulty compressor
- Faulty fan motor
- Faulty connection of signal cable

U2

Troubleshooting



Caution

Be sure to turn off power switch before connect or disconnect connector, or parts damage may be occurred.

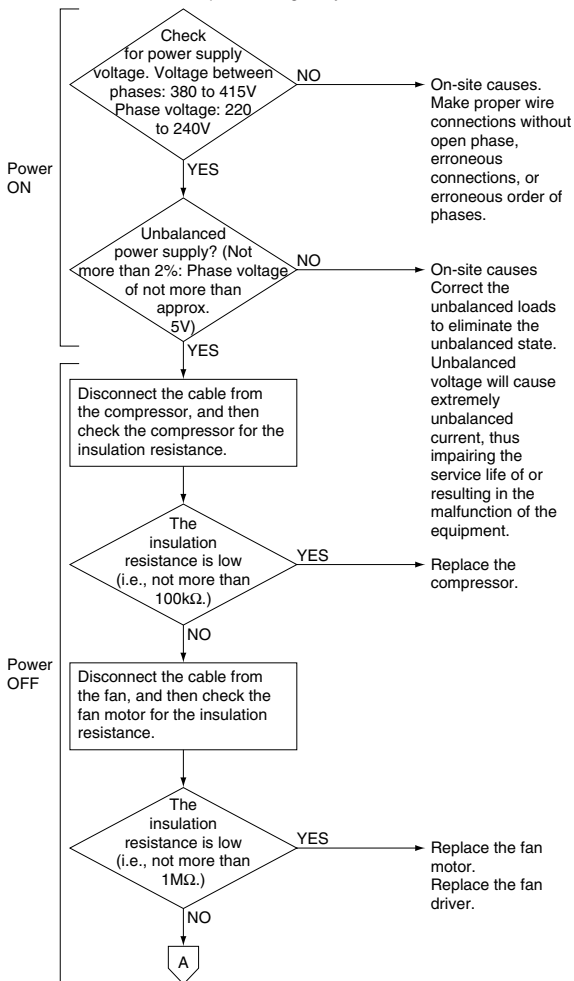



Caution

Be sure to turn off power switch before connect or disconnect connector, or parts damage may be occurred.

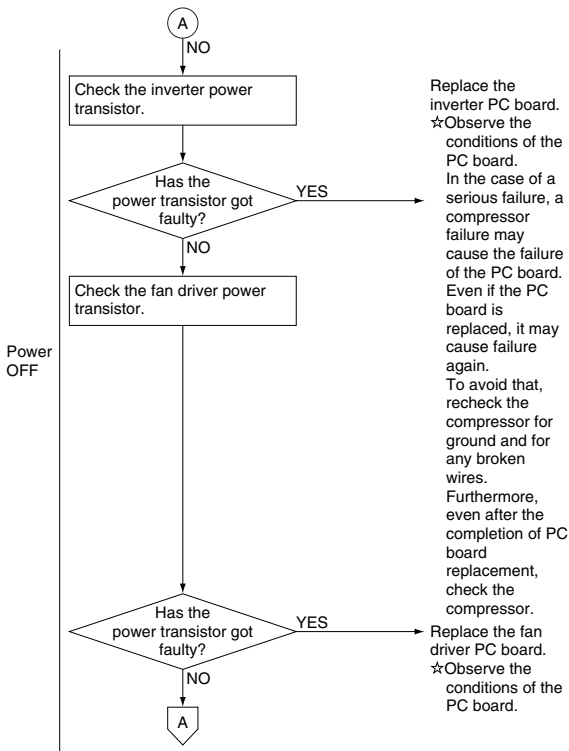

U2



Caution

Be sure to turn off power switch before connect or disconnect connector, or parts damage may be occurred.

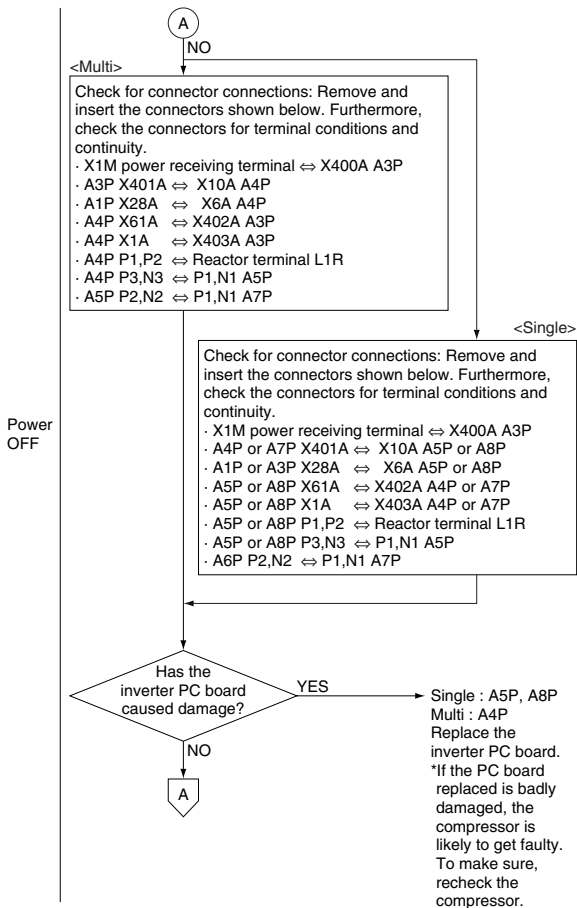



Caution

Be sure to turn off power switch before connect or disconnect connector, or parts damage may be occurred.

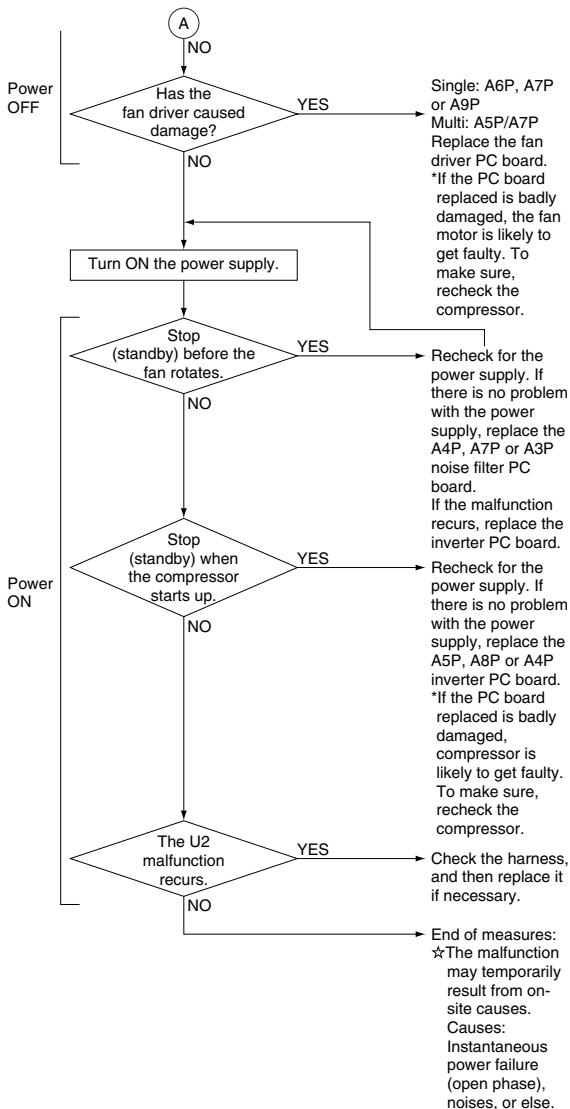

U2

Remote Controller Display

U2

Applicable Models

VRV II-S Series

Method of Malfunction Detection

Detection of voltage of main circuit capacitor built in the inverter and power supply voltage.

Supposed Causes

- Power supply insufficient
- Instantaneous failure
- Defect of inverter PC board
- Defect of outdoor control PC board
- Main circuit wiring defect

Troubleshooting



Caution

Be sure to turn off power switch before connect or disconnect connector, or parts damage may be occurred.

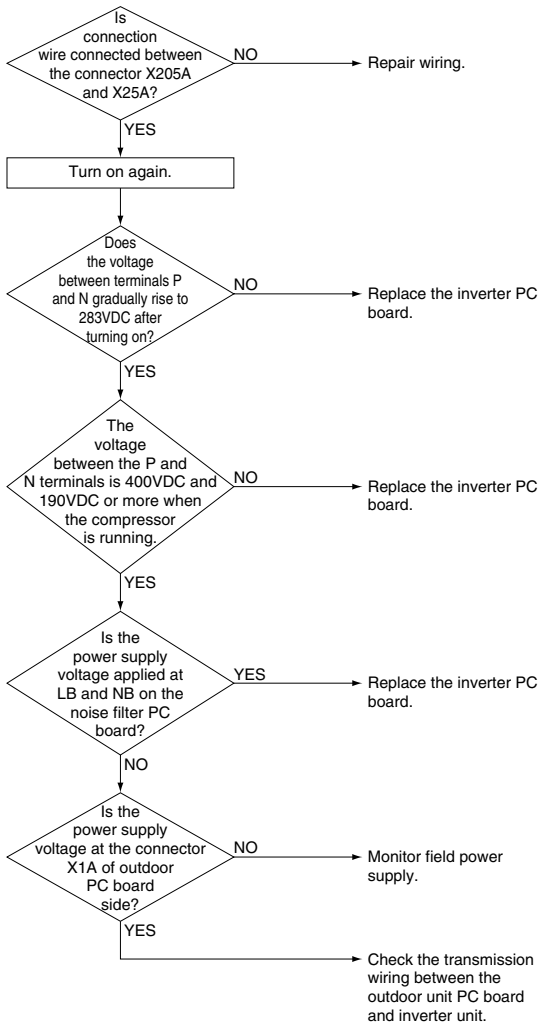

U2

Remote Controller Display

U2

Applicable Models

VRV III-S Series

Method of Malfunction Detection

Detection of voltage of main circuit capacitor built in the inverter and power supply voltage.

Malfunction Decision Conditions

When the abnormal voltage of main circuit capacitor built in the inverter and abnormal power supply voltage are detected.

Supposed Causes

- Power supply insufficient
- Instantaneous power failure
- Defect of outdoor unit fan motor
- Defect of outdoor control PC board (A1P)

Troubleshooting



Caution

Be sure to turn off power switch before connect or disconnect connector, or parts damage may be occurred.

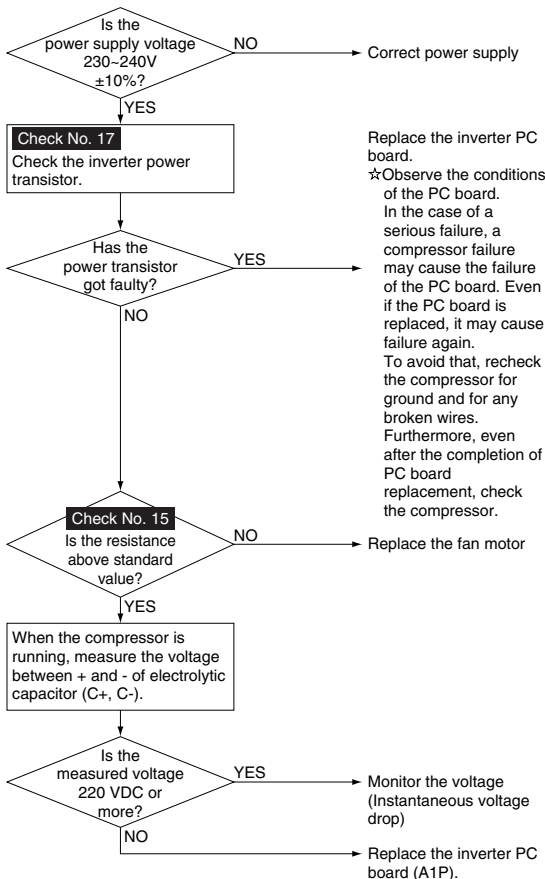

U2



Refer to Check No. 15, 17 on page 389, 391.

(48) Check Operation not Executed

Remote Controller Display

U3

Applicable Models

All indoor unit models

Method of Malfunction Detection

Check operation is executed or not

Malfunction Decision Conditions

Malfunction is decided when the unit starts operation without check operation.

Supposed Causes

- Check operation is not executed.

Troubleshooting



Caution

Be sure to turn off power switch before connect or disconnect connector, or parts damage may be occurred.

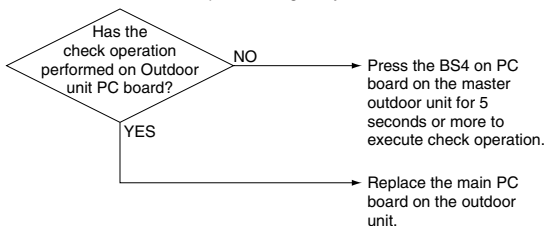

(49) Malfunction of Transmission Between Indoor Units

Remote Controller Display

U4

Applicable Models

VRV II, II-S, WII, III-S (50/60Hz) and III
H/P Series

Method of Malfunction Detection

Microcomputer checks if transmission between indoor and outdoor units is normal.

Malfunction Decision Conditions

When transmission is not carried out normally for a certain amount of time

Supposed Causes

- Indoor to outdoor, outdoor to outdoor transmission wiring F1, F2 disconnection, short circuit or wrong wiring
- Outdoor unit power supply is OFF
- System address doesn't match
- Defect of indoor unit PC board
- Defect of outdoor unit PC board

U3

U4

Troubleshooting



Caution

Be sure to turn off power switch before connect or disconnect connector, or parts damage may be occurred.

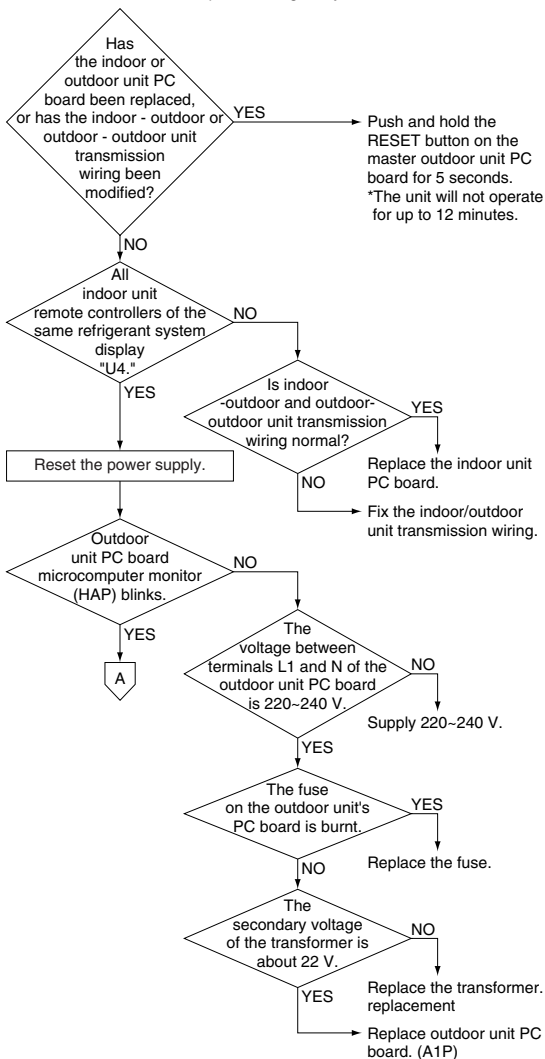

**Caution**

Be sure to turn off power switch before connect or disconnect connector, or parts damage may be occurred.

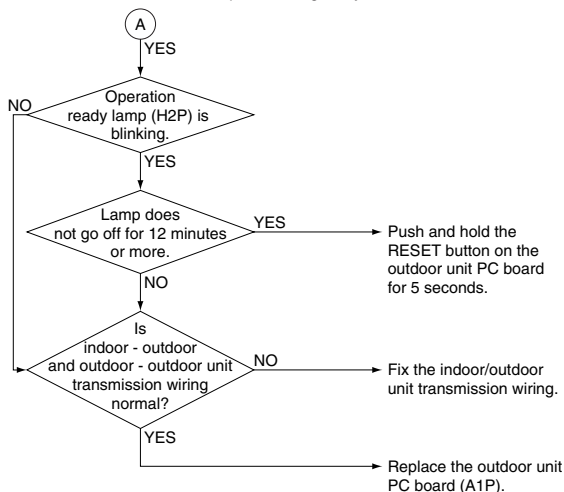
**U4**

Remote Controller Display

U4

Applicable Models

VRV III H/R and C/O Series

Method of Malfunction Detection

Check if the transmission between indoor unit and outdoor unit is correctly executed using microcomputer.

Malfunction Decision Conditions

When transmission is not carried out normally for a certain amount of time

Supposed Causes

- Indoor to outdoor, outdoor to outdoor transmission wiring F1, F2 disconnection, short circuit or wrong wiring
- Outdoor unit power supply is OFF
- System address doesn't match
- Defect of indoor unit PC board
- Defect of outdoor unit PC board

Troubleshooting

Caution Be sure to turn off power switch before connect or disconnect connector, or parts damage may be occurred.

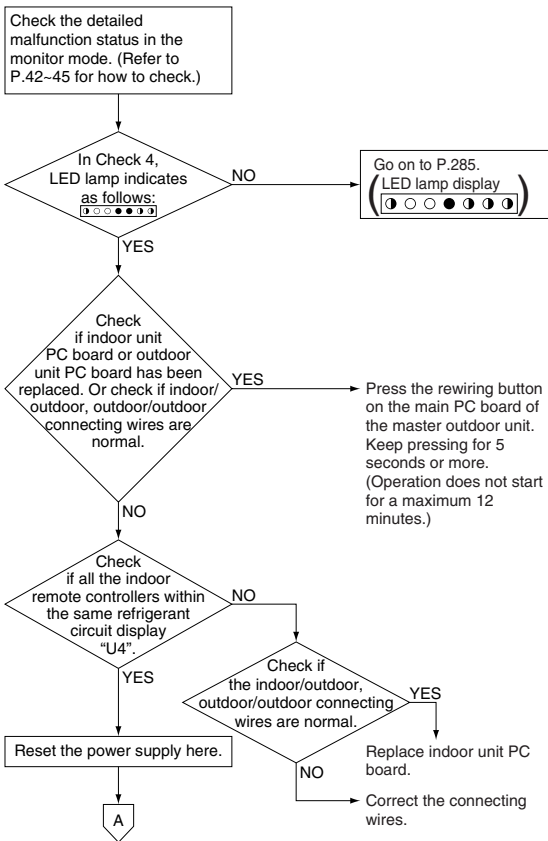

U4



Caution

Be sure to turn off power switch before connect or disconnect connector, or parts damage may be occurred.

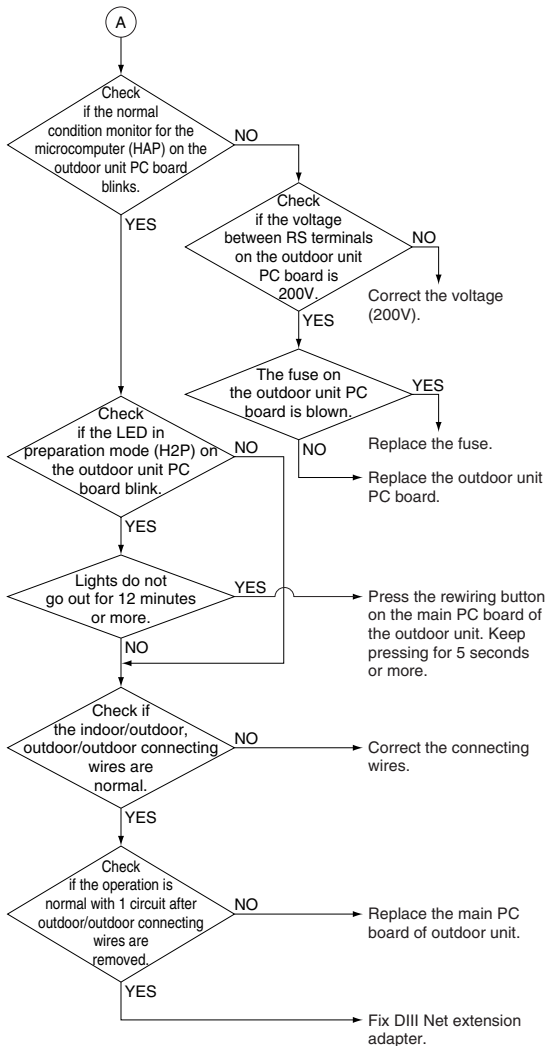

Troubleshooting



Caution

Be sure to turn off power switch before connect or disconnect connector, or parts damage may be occurred.

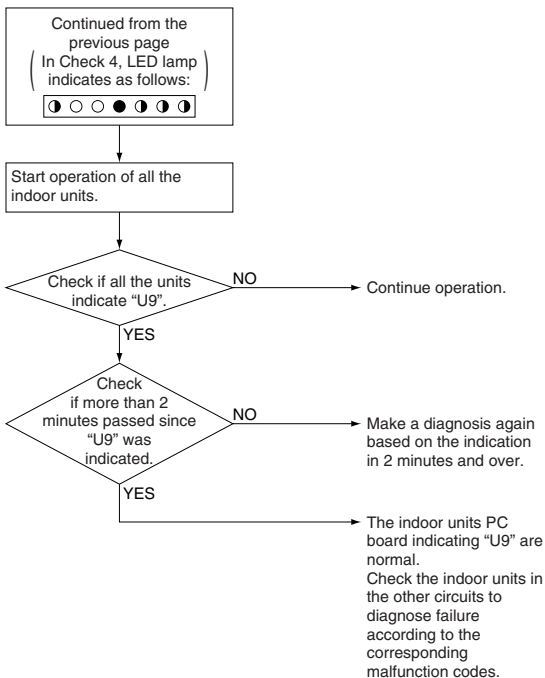

U4

Remote Controller Display

U4

Applicable Models

VRV III-S (50Hz) Series

Method of Malfunction Detection

Microcomputer checks if transmission between indoor and outdoor units is normal.

Malfunction Decision Conditions

When transmission is not carried out normally for a certain amount of time

Supposed Causes

- Indoor to outdoor, outdoor to outdoor transmission wiring F1, F2 disconnection, short circuit or wrong wiring
- Outdoor unit power supply is OFF
- System address doesn't match
- Defect of outdoor unit PC board
- Defect of indoor unit PC board

Troubleshooting



Caution

Be sure to turn off power switch before connect or disconnect connector, or parts damage may be occurred.

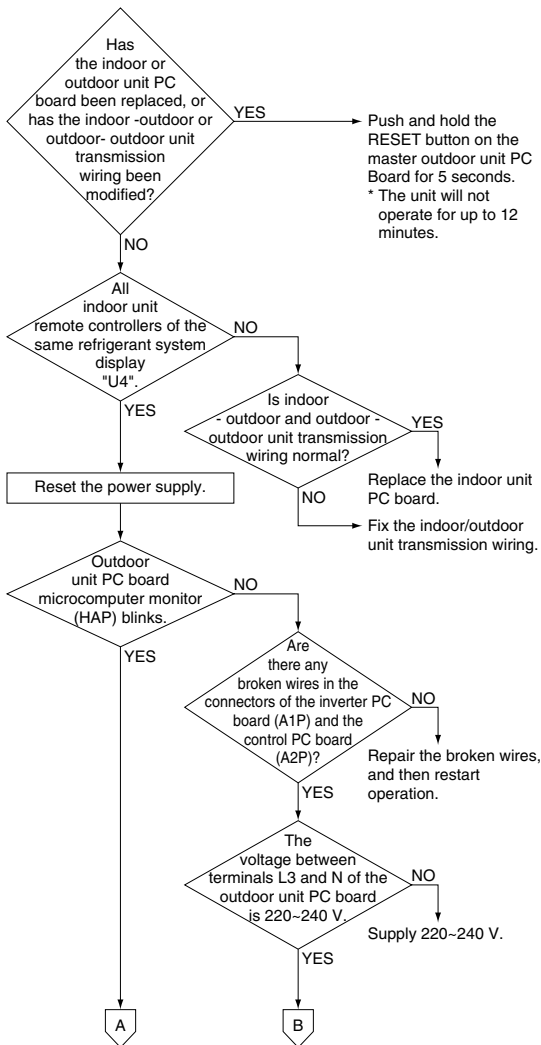

U4



Caution

Be sure to turn off power switch before connect or disconnect connector, or parts damage may be occurred.

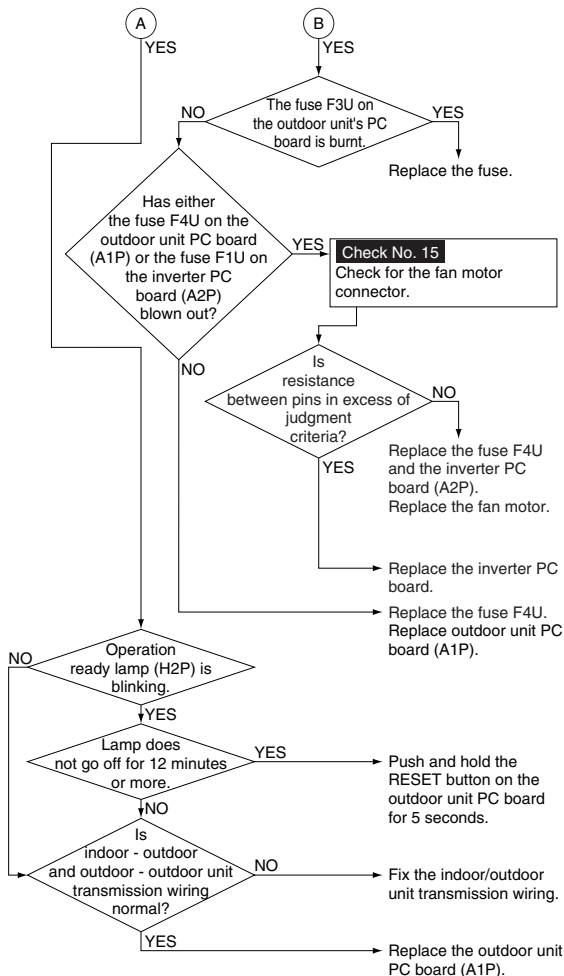

Refer to Check No. 15 on page 389.

(50) Malfunction of Transmission Between Remote Controller and Indoor Unit

Remote Controller Display

U5

Applicable Models

except VRV III (50Hz) Series

Method of Malfunction Detection

In case of controlling with 2-remote controller, check the system using microcomputer is signal transmission between indoor unit and remote controller (main and sub) is normal.

Malfunction Decision Conditions

Normal transmission does not continue for specified period.

Supposed Causes

- Malfunction of indoor unit remote controller transmission
- Connection of two main remote controllers (when using 2 remote controllers)
- Defect of indoor unit PC board
- Defect of remote controller PC board
- Malfunction of transmission caused by noise

U4

U5

Troubleshooting



Caution

Be sure to turn off power switch before connect or disconnect connector, or parts damage may be occurred.

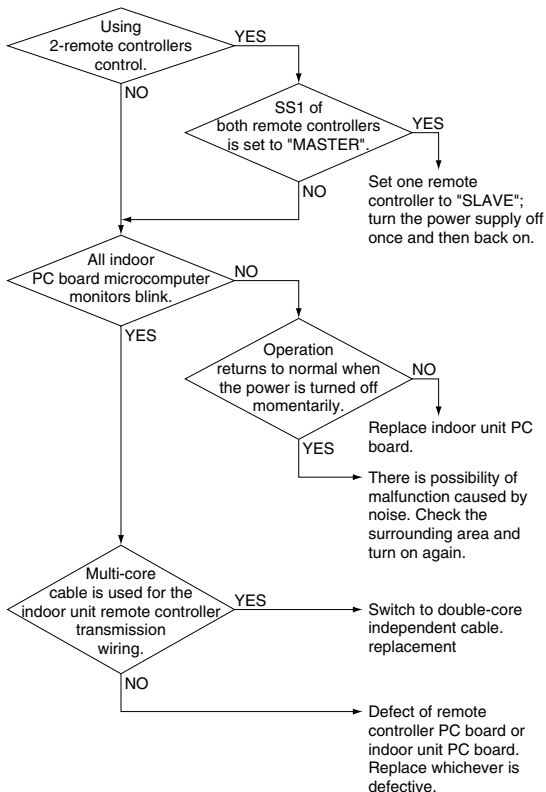

Remote Controller Display

U5

Applicable Models

VRV III (50Hz) Series

Method of Malfunction Detection

In case of controlling with 2-remote controller, check the system using microcomputer is signal transmission between indoor unit and remote controller (main and sub) is normal.

Malfunction Decision Conditions

Normal transmission does not continue for specified period.

Supposed Causes

- Malfunction of indoor unit remote controller transmission
- Connection of two main remote controllers (when using 2 remote controllers)
- Defect of indoor unit PC board
- Defect of remote controller PC board
- Malfunction of transmission caused by noise

U5

Troubleshooting



Caution

Be sure to turn off power switch before connect or disconnect connector, or parts damage may be occurred.

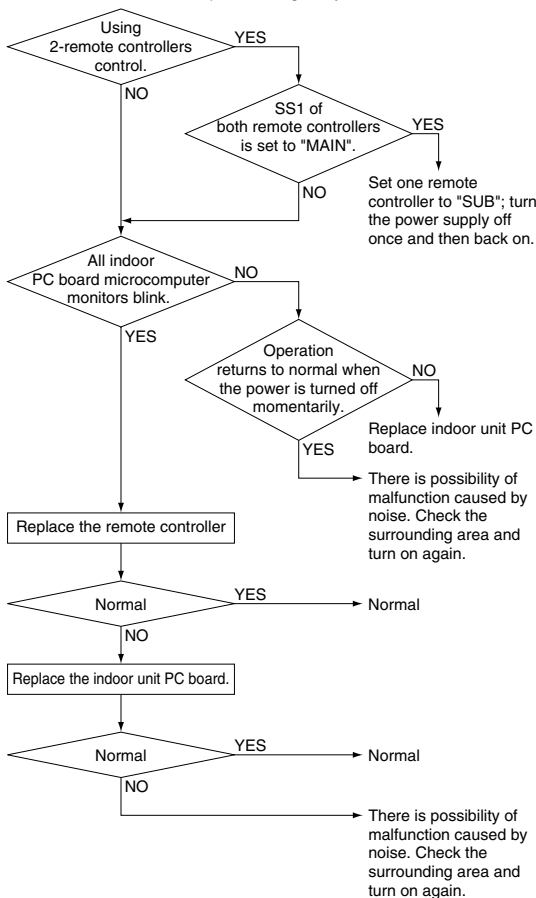

(51) Malfunction of Transmission Between Outdoor Units

Remote Controller Display

U7

Applicable Models

VRV II, WII and III (60Hz) Series

Method of Malfunction Detection

Microcomputer checks if transmission between indoor unit and remote controller is normal.

Malfunction Decision Conditions

When transmission is not carried out normally for a certain amount of time

Supposed Causes

- Improper connection of transmission wiring between outdoor unit and outdoor unit outside control adaptor
- Improper cool/heat selection
- Improper cool/heat unified address (outdoor unit, external control adaptor for outdoor unit)
- Defect of outdoor unit PC board (A1P)
- Defect of outdoor unit outside control adaptor
- Improper connection of transmission wiring between outdoor units of multi outdoor unit connection.

U5

U7

Troubleshooting



Caution

Be sure to turn off power switch before connect or disconnect connector, or parts damage may be occurred.

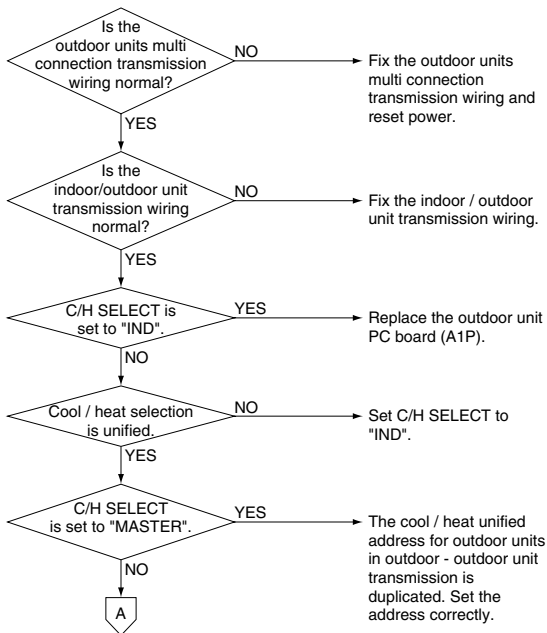



Caution

Be sure to turn off power switch before connect or disconnect connector, or parts damage may be occurred.

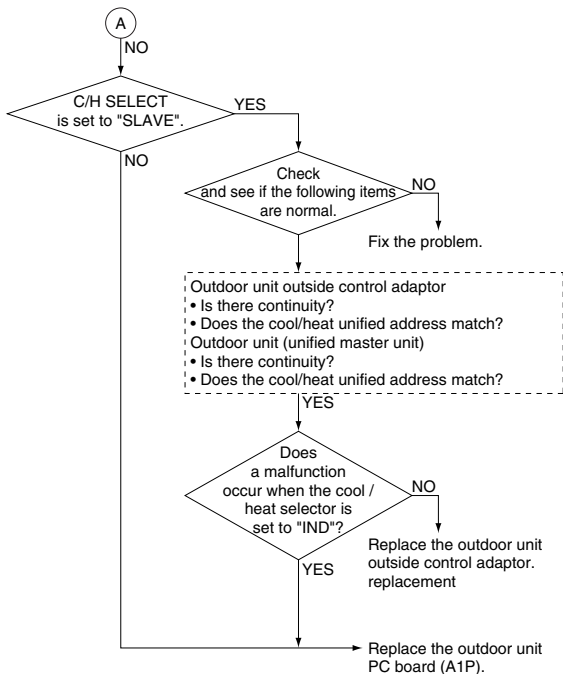

U7

Remote Controller Display

U7

Applicable Models

VRV III H/R and C/O Series

Method of Malfunction Detection

Microcomputer checks if transmission between outdoor units.

Malfunction Decision Conditions

When transmission is not carried out normally for a certain amount of time

Supposed Causes

- Connection error in connecting wires between outdoor unit and outdoor unit outside control adapter
- Connection error in connecting wires across outdoor units
- Setting error in switching cooling/ heating
- Integrated address setting error for cooling/ heating (function unit, outdoor unit outside control adapter)
- Defective outdoor unit PC board (A1P or A3P)
- Defective outdoor unit outside control adapter

Troubleshooting



Caution

Be sure to turn off power switch before connect or disconnect connector, or parts damage may be occurred.

Check the LED lamps for "Check 3" corresponding to the malfunction code "U7" and for Check 4 in the monitor mode. (Refer to P.42-45 for how to check)

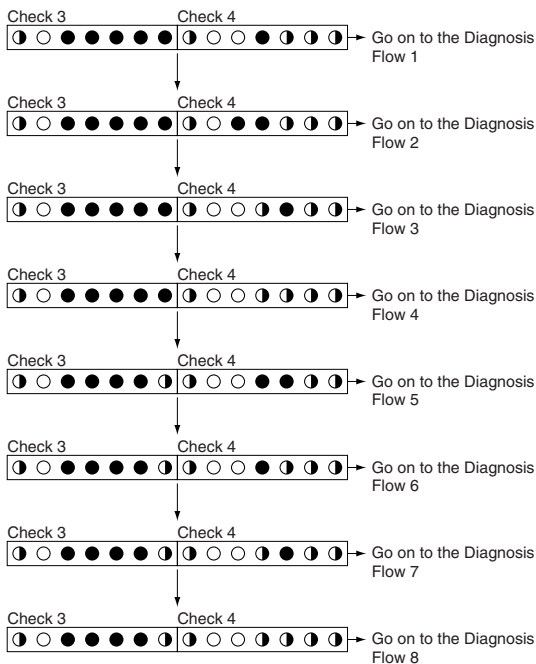

U7

Troubleshooting



Caution

Be sure to turn off power switch before connect or disconnect connector, or parts damage may be occurred.

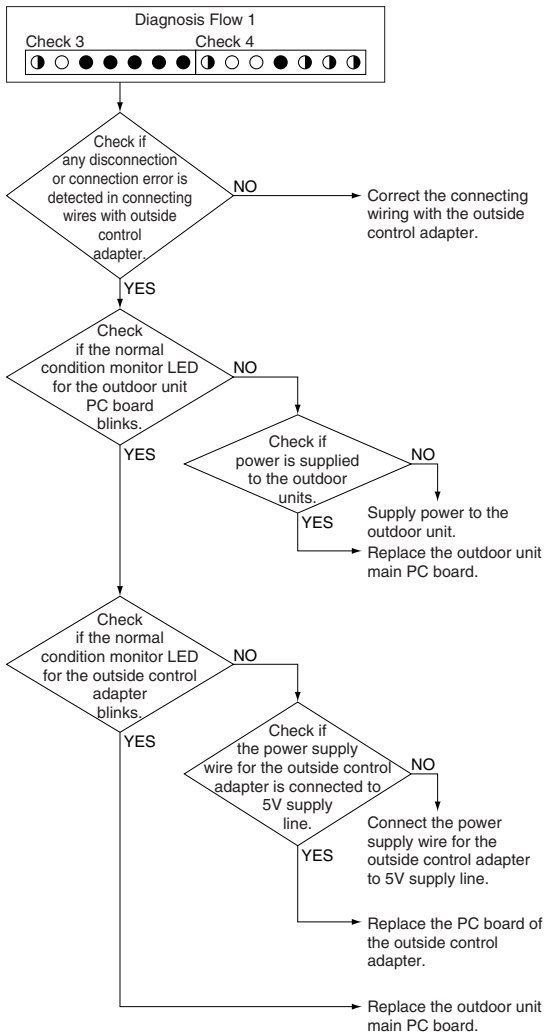

Troubleshooting



Caution

Be sure to turn off power switch before connect or disconnect connector, or parts damage may be occurred.

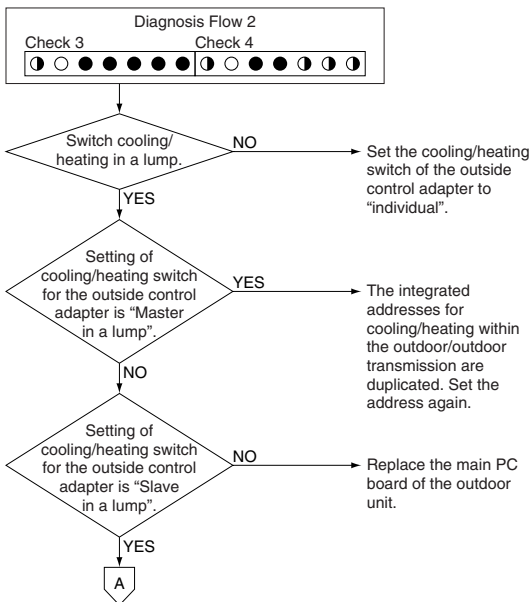

U7



Caution

Be sure to turn off power switch before connect or disconnect connector, or parts damage may be occurred.

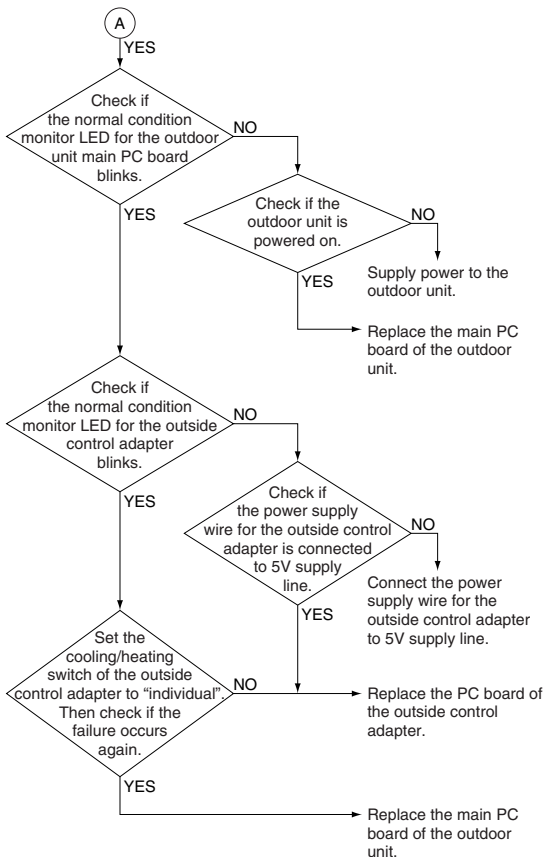

Troubleshooting



Caution

Be sure to turn off power switch before connect or disconnect connector, or parts damage may be occurred.

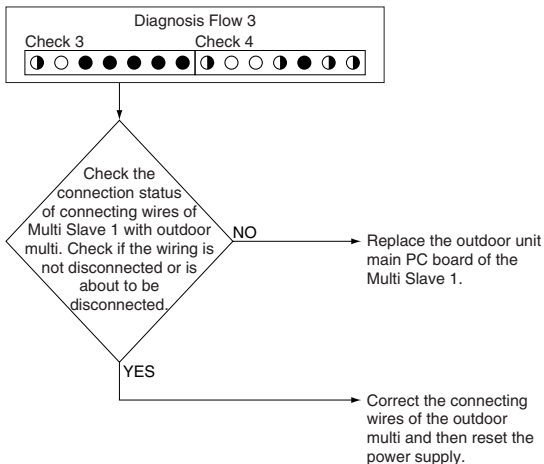

U7

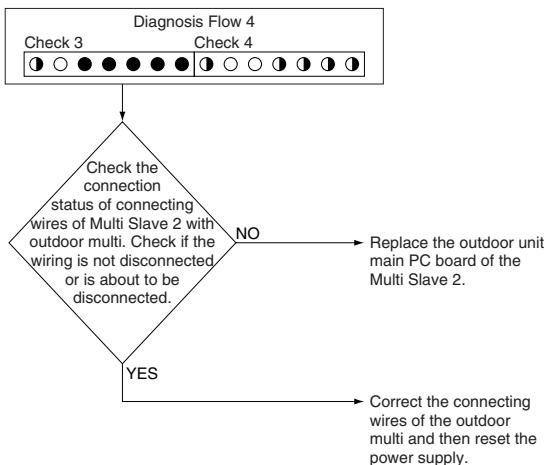

Troubleshooting



Caution

Be sure to turn off power switch before connect or disconnect connector, or parts damage may be occurred.

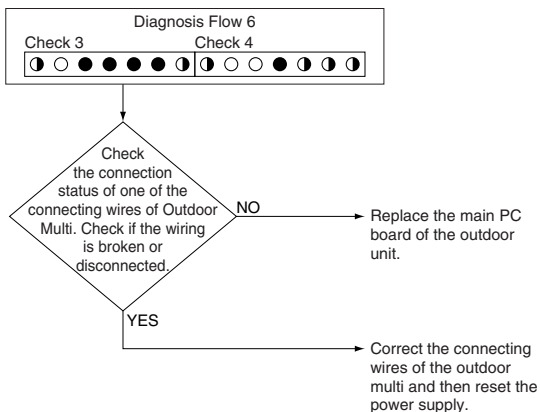
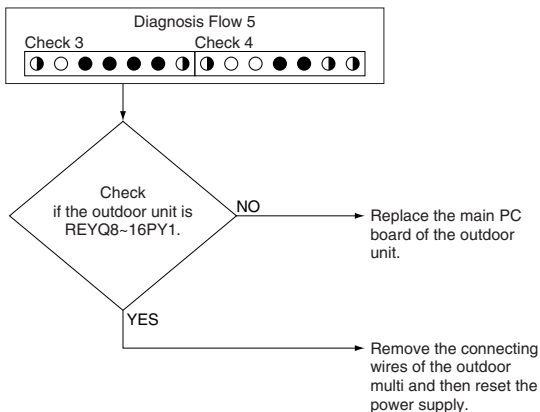

Troubleshooting



Caution

Be sure to turn off power switch before connect or disconnect connector, or parts damage may be occurred.

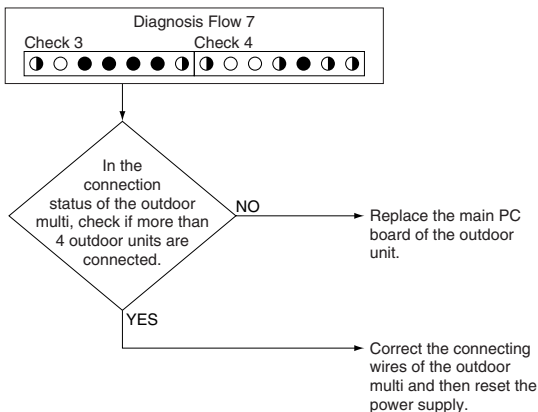

U7

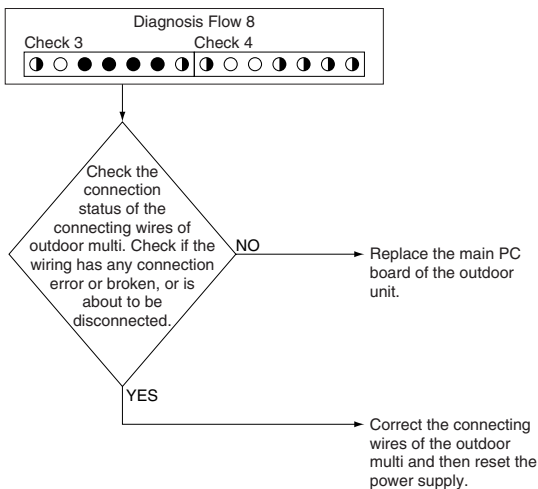

Remote Controller Display

U7

Applicable Models

VRV III (50Hz) Series

Method of Malfunction Detection

Microcomputer checks if transmission between outdoor units.

Malfunction Decision Conditions

When transmission is not carried out normally for a certain amount of time

Supposed Causes

- Improper connection of transmission wiring between outdoor unit and external control adaptor for outdoor unit
- Improper connection of transmission wiring between outdoor units.
- Improper cool/heat selection
- Improper cool/heat unified address (outdoor unit, external control adaptor for outdoor unit)
- Defect of outdoor unit PC board (A1P)
- Defect of external control adaptor for outdoor unit

Troubleshooting



Caution

Be sure to turn off power switch before connect or disconnect connector, or parts damage may be occurred.

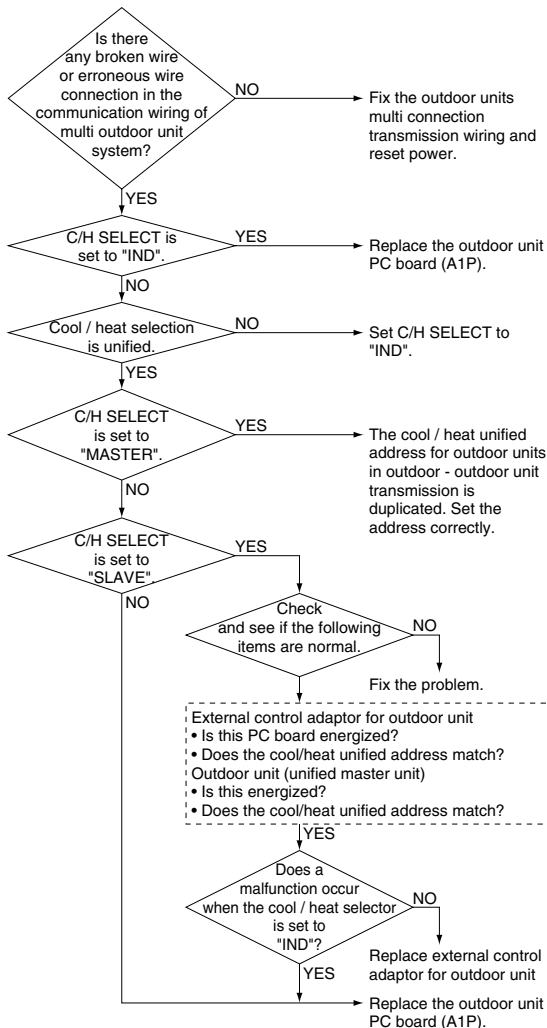

U7

(52) Malfunction of Transmission Between Master and Slave Remote Controllers

Remote Controller Display

U8

Applicable Models

All indoor unit models

Method of Malfunction Detection

In case of controlling with 2-remote controller, check the system using microcomputer if signal transmission between indoor unit and remote controller (main and sub) is normal.

Malfunction Decision Conditions

Normal transmission does not continue for specified period.

Supposed Causes

- Malfunction of transmission between main and sub remote controller
- Connection between sub remote controllers
- Defect of remote controller PC board

Troubleshooting



Caution

Be sure to turn off power switch before connect or disconnect connector, or parts damage may be occurred.

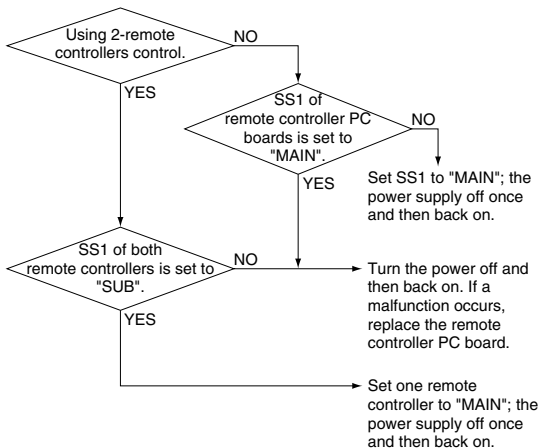

U8

(53) Malfunction of Transmission Between Indoor and Outdoor Units in the Same System

Remote Controller Display

U9

Applicable Models

VRV II, II-S, WII and III-S Series

Method of Malfunction Detection

Malfunction Decision Conditions

Supposed Causes

- Malfunction of transmission within or outside of other system
- Malfunction of electronic expansion valve in indoor unit of other system
- Defect of PC board of indoor unit in other system
- Improper connection of transmission wiring between indoor and outdoor unit

Troubleshooting



Caution

Be sure to turn off power switch before connect or disconnect connector, or parts damage may be occurred.

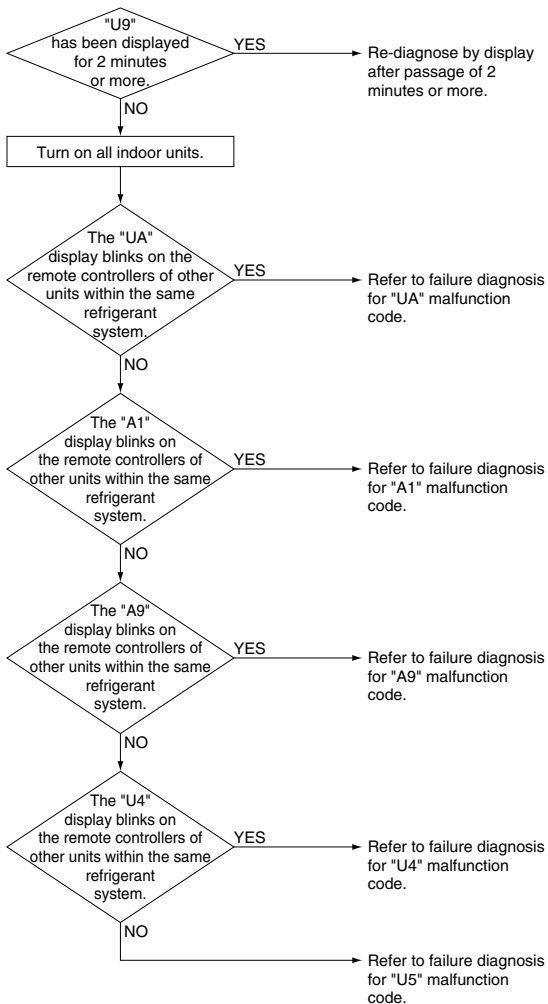

U9

Remote Controller Display

U9

Applicable Models

VRV III (60Hz), H/R and C/O Series

Method of Malfunction Detection

Detect malfunction signal for the other indoor units within the circuit by outdoor unit PC board.

Malfunction Decision Conditions

When the malfunction decision is made on any other indoor unit within the system concerned.

Supposed Causes

- Malfunction of transmission within or outside of other system
- Malfunction of electronic expansion valve in indoor unit of other system
- Defect of PC board of indoor unit in other system
- Improper connection of transmission wiring between indoor and outdoor unit

Troubleshooting



Caution

Be sure to turn off power switch before connect or disconnect connector, or parts damage may be occurred.

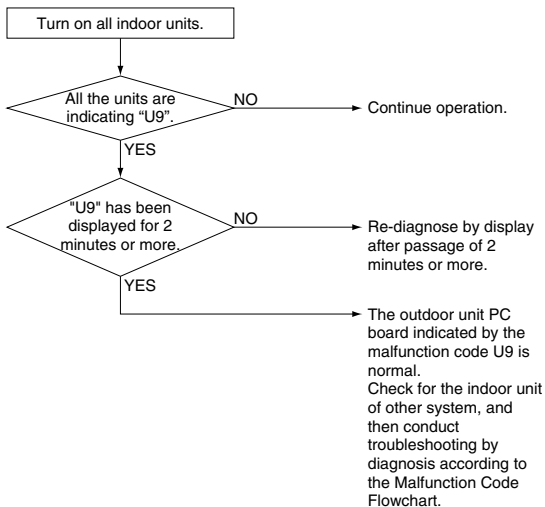

U9

Remote Controller Display

U9

Applicable Models

VRV III (50Hz) Series

Method of Malfunction Detection

Detect the malfunction signal of any other indoor unit within the system concerned.

Malfunction Decision Conditions

When the malfunction decision is made on any other indoor unit within the system concerned.

Supposed Causes

- Malfunction of transmission within or outside of other system
- Malfunction of electronic expansion valve in indoor unit of other system
- Defect of PC board of indoor unit in other system
- Improper connection of transmission wiring between indoor and outdoor unit

Troubleshooting



Caution

Be sure to turn off power switch before connect or disconnect connector, or parts damage may be occurred.

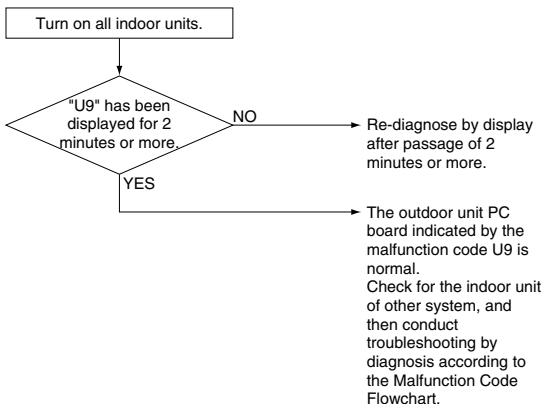

U9

(54) Excessive Number of Indoor Units

Remote Controller Display

UR

Applicable Models

VRV II, II-S, WII and III-S Series

Supposed Causes

- Excess of connected indoor units
- Defect of outdoor unit PC board (A1P)
- Mismatching of the refrigerant type of indoor and outdoor unit.
- Setting of outdoor PC board was not conducted after replacing to spare parts PC board.

Troubleshooting



Caution

Be sure to turn off power switch before connect or disconnect connector, or parts damage may be occurred.

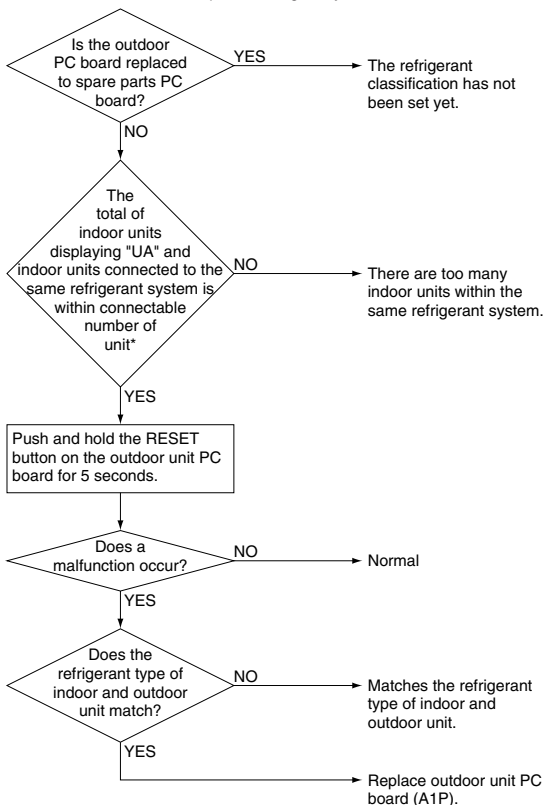

UA

* The number of indoor units that can be connected to a single outdoor unit system depends on the type of outdoor unit.

Remote Controller Display

UR

Applicable Models

VRV III H/R and C/O Series

Method of Malfunction Detection

A difference occurs in data by the type of refrigerant between indoor and outdoor units.

The number of indoor units is out of the allowable range.

Malfunction Decision Conditions

The malfunction decision is made as soon as either of the abnormalities aforementioned is detected.

Supposed Causes

- Excess of connected indoor units
- Defect of outdoor unit PC board (A1P)
- Mismatching of the refrigerant type of indoor and outdoor unit.
- Setting of outdoor PC board was not conducted after replacing to spare parts PC board.

Troubleshooting



Caution

Be sure to turn off power switch before connect or disconnect connector, or parts damage may be occurred.

Check the LED lamps for "Check 3" corresponding to the malfunction code "UA" and for Check 4 in the monitor mode. (Refer to P.42~45 for how to check.)

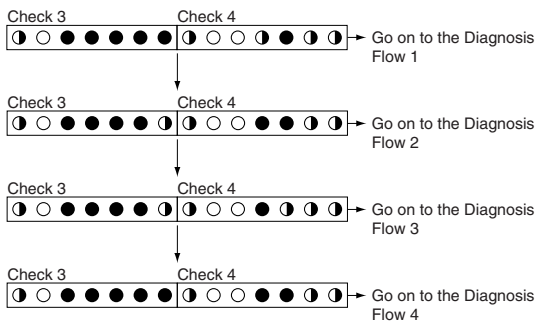

UA

Troubleshooting



Caution

Be sure to turn off power switch before connect or disconnect connector, or parts damage may be occurred.

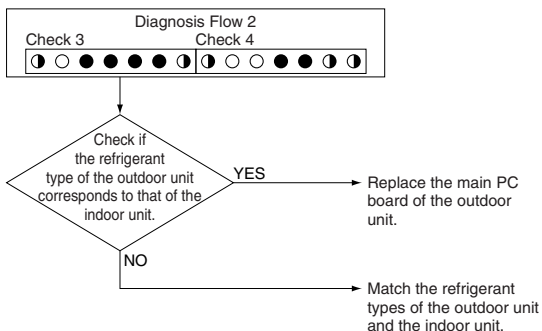
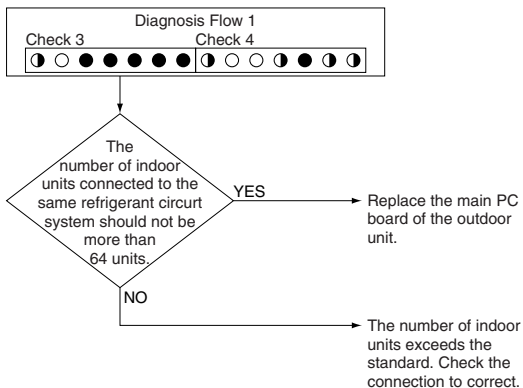

Troubleshooting



Caution

Be sure to turn off power switch before connect or disconnect connector, or parts damage may be occurred.

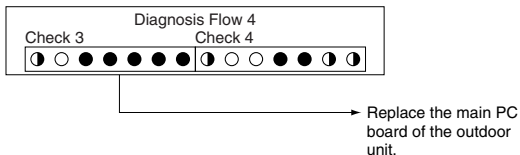
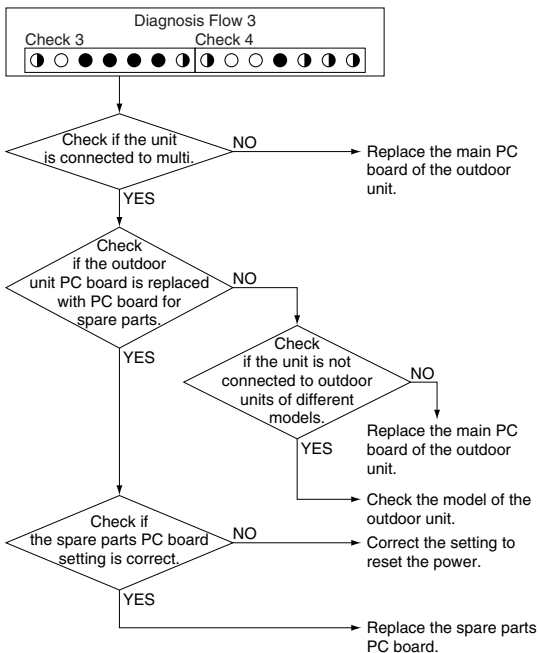

UA

Remote Controller Display

UR

Applicable Models

VRV III Series

Method of Malfunction Detection

A difference occurs in data by the type of refrigerant between indoor and outdoor units.

The number of indoor units is out of the allowable range.

Malfunction Decision Conditions

The malfunction decision is made as soon as either of the abnormalities aforementioned is detected.

Supposed Causes

- Excess of connected indoor units
- Defect of outdoor unit PC board (A1P)
- Mismatching of the refrigerant type of indoor and outdoor unit.
- Setting of outdoor PC board was not conducted after replacing to spare parts PC board.

Troubleshooting



Caution

Be sure to turn off power switch before connect or disconnect connector, or parts damage may be occurred.

Reset all power supplies for indoor and outdoor units connected to one and the same system.

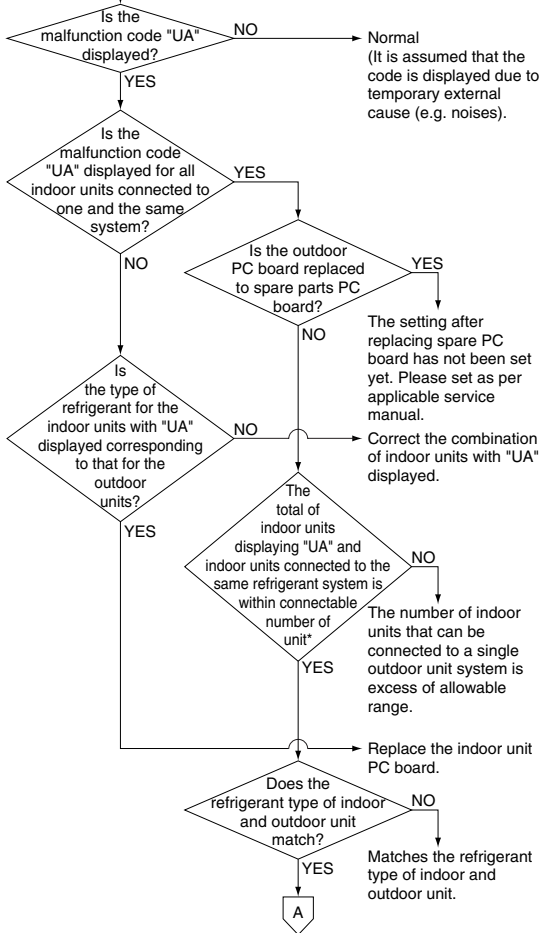

UA

**Caution**

Be sure to turn off power switch before connect or disconnect connector, or parts damage may be occurred.

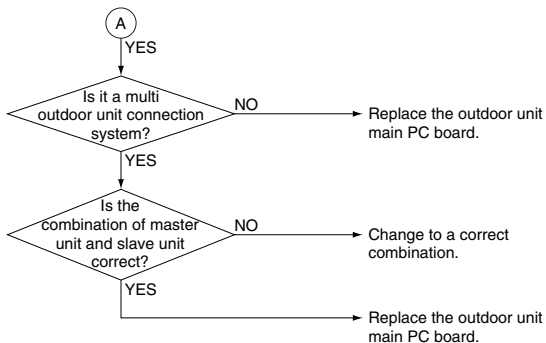

* The number of indoor units that can be connected to a single outdoor unit system depends on the model of outdoor unit.

(55) Address Duplication of Central Remote Controller

Remote Controller Display

UC

Applicable Models

VRV II, II-S, WII and III-S Series
Centralized controller

Supposed Causes

- Address duplication of centralized remote controller
- Defect of indoor unit PC board

Troubleshooting



Caution

Be sure to turn off power switch before connect or disconnect connector, or parts damage may be occurred.

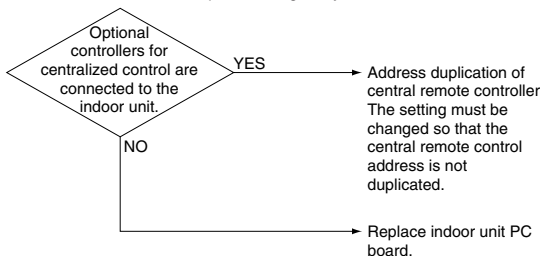

UA

UC

Remote Controller Display

UC

Applicable Models

VRV III Series

Centralized controller

Method of Malfunction Detection

The principal indoor unit detects the same address as that of its own on any other indoor unit.

Malfunction Decision Conditions

The malfunction decision is made as soon as the abnormality aforementioned is detected.

Supposed Causes

- Address duplication of centralized controller

Troubleshooting



Caution

Be sure to turn off power switch before connect or disconnect connector, or parts damage may be occurred.

The centralized address is duplicated.

→ Make setting change so that the centralized address will not be duplicated.

(56) Malfunction of Transmission Between Central Remote Controller and Indoor Unit

Remote Controller Display

UE

Applicable Models

VRV II, II-S, WII and III-S Series

Method of Malfunction Detection

Microcomputer checks if transmission between indoor unit and centralized remote controller is normal.

Malfunction Decision Conditions

When transmission is not carried out normally for a certain amount of time

UC

UE

Supposed Causes

- Malfunction of transmission between optional controllers for centralized control and indoor unit
- Connector for setting master controller is disconnected.
- Failure of PC board for centralized remote controller
- Defect of indoor unit PC board

Troubleshooting



Caution

Be sure to turn off power switch before connect or disconnect connector, or parts damage may be occurred.

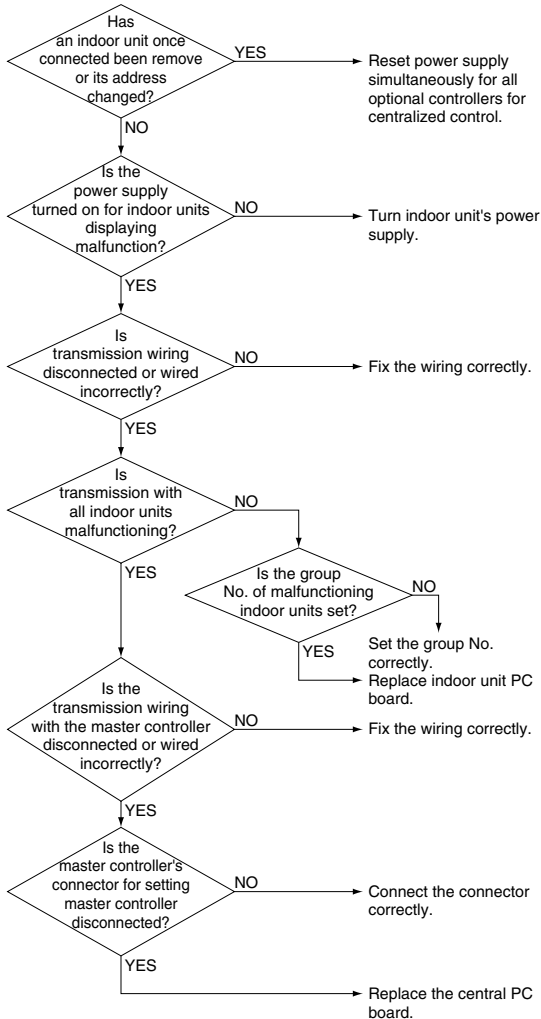

Remote Controller Display

UE

Applicable Models

VRV III Series
Intelligent Touch Controller
Centralized controller
Schedule timer

Method of Malfunction Detection

Microcomputer checks if transmission between indoor unit and centralized controller is normal.

Malfunction Decision Conditions

When transmission is not carried out normally for a certain amount of time

UE

Supposed Causes

- Malfunction of transmission between optional controllers for centralized control and indoor unit
- Connector for setting master controller is disconnected.
(or disconnection of connector for independent / combined use changeover switch.)
- Failure of PC board for central remote controller
- Defect of indoor unit PC board

Troubleshooting



Caution

Be sure to turn off power switch before connect or disconnect connector, or parts damage may be occurred.

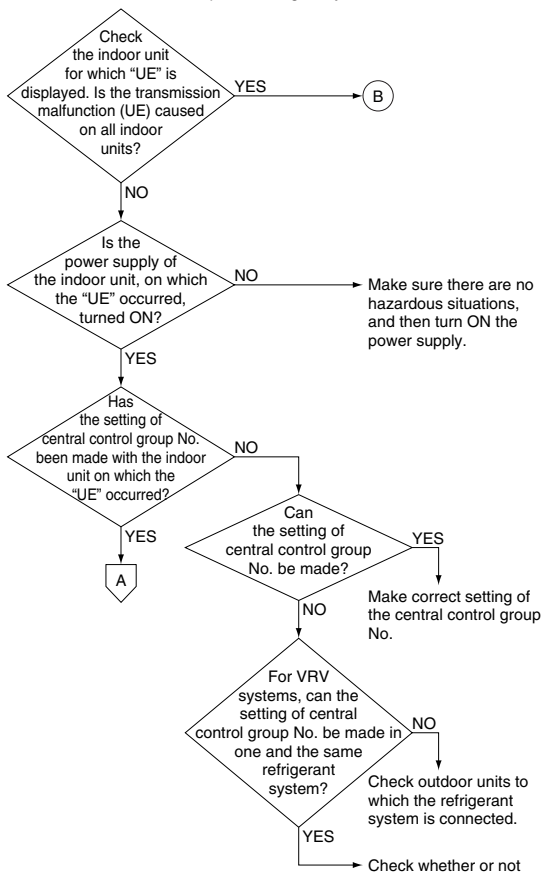

**Caution**

Be sure to turn off power switch before connect or disconnect connector, or parts damage may be occurred.

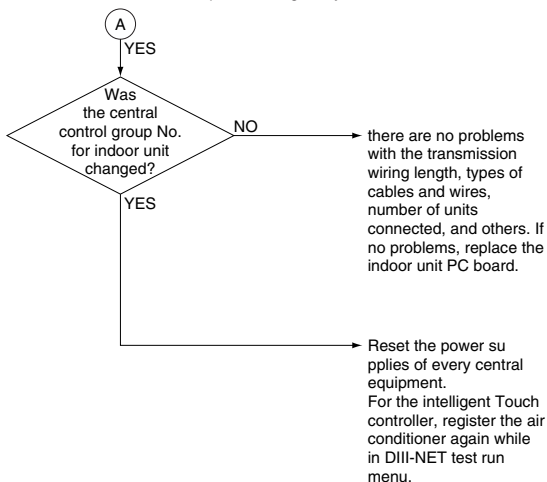
**UE**



Caution

Be sure to turn off power switch before connect or disconnect connector, or parts damage may be occurred.

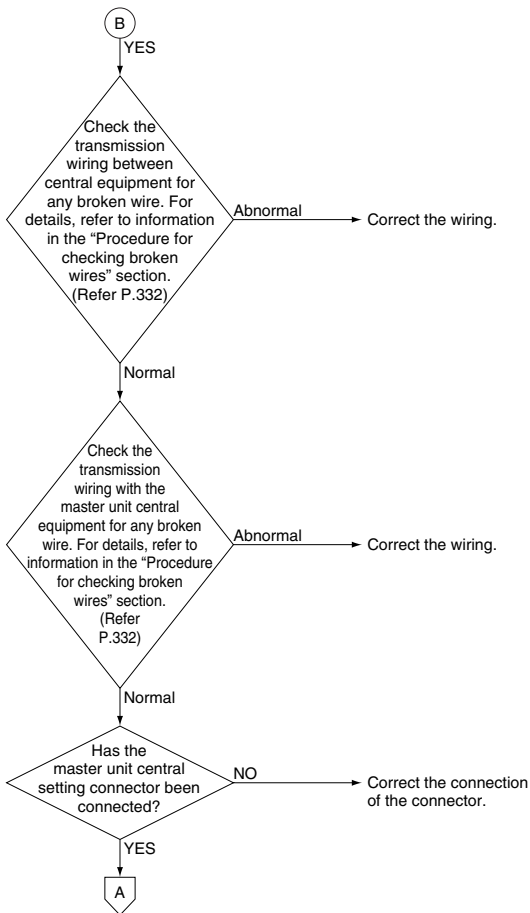

**Caution**

Be sure to turn off power switch before connect or disconnect connector, or parts damage may be occurred.

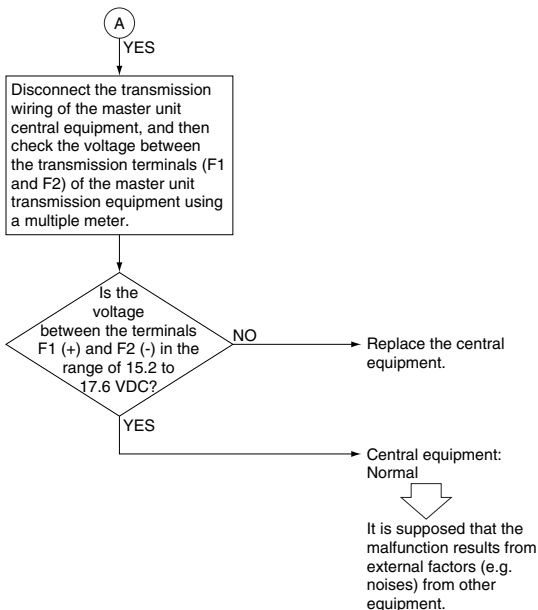
**UE**

(57) Refrigerant System not Set, Incompatible Wiring/Piping

Remote Controller Display

UF

Applicable Models

All indoor unit models

Supposed Causes

- Improper connection of transmission wiring between outdoor unit and outdoor unit outside control adaptor
- Failure to execute wiring check operation
- Defect of indoor unit PC board

Troubleshooting



Caution

Be sure to turn off power switch before connect or disconnect connector, or parts damage may be occurred.

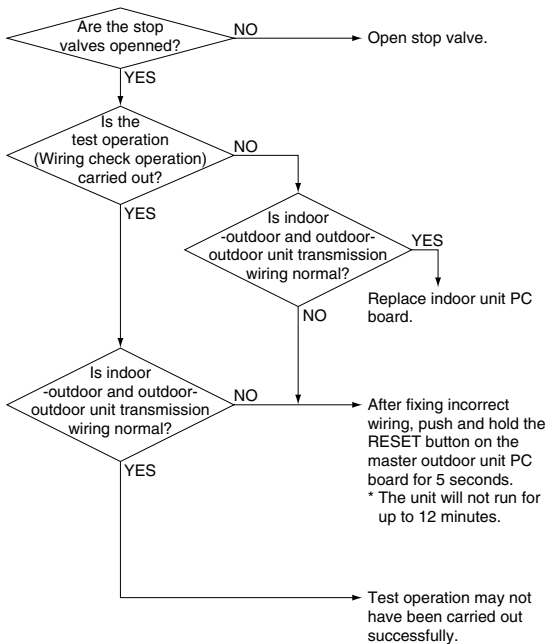

UF



Note:

Test operation may not be successful if carried out after the outdoor unit has been off for more than 12 hours, or if it is not carried out after running all connected indoor units in the fan mode for at least an hour.

(58) Malfunction of System, Refrigerant System Address Undefined

Remote Controller Display

UH

Applicable Models

except VRV III (50Hz) Series

Supposed Causes

- Improper connection of transmission wiring between outdoor unit and outdoor unit outside control adaptor
- Defect of indoor unit PC board
- Defect of outdoor unit PC board (A1P)

Troubleshooting



Caution

Be sure to turn off power switch before connect or disconnect connector, or parts damage may be occurred.

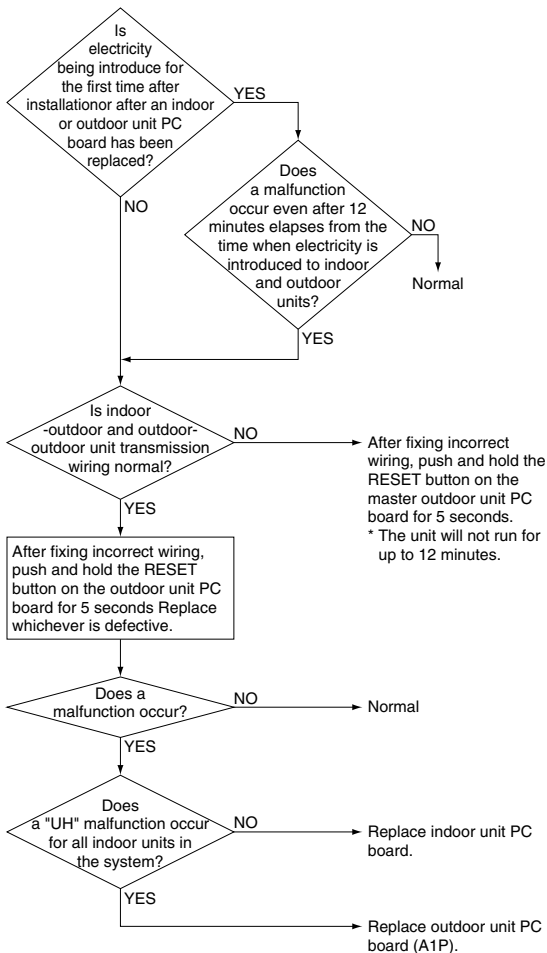

UH

Remote Controller Display

UH

Applicable Models

VRV III (50Hz) Series

Method of Malfunction Detection

Detect an indoor unit with no address setting.

Malfunction Decision Conditions

The malfunction decision is made as soon as the abnormality aforementioned is detected.

Supposed Causes

- Improper connection of transmission wiring between indoor-outdoor units and outdoor-outdoor units
- Defect of indoor unit PC board
- Defect of outdoor unit PC board (A1P)

Troubleshooting



Caution

Be sure to turn off power switch before connect or disconnect connector, or parts damage may be occurred.

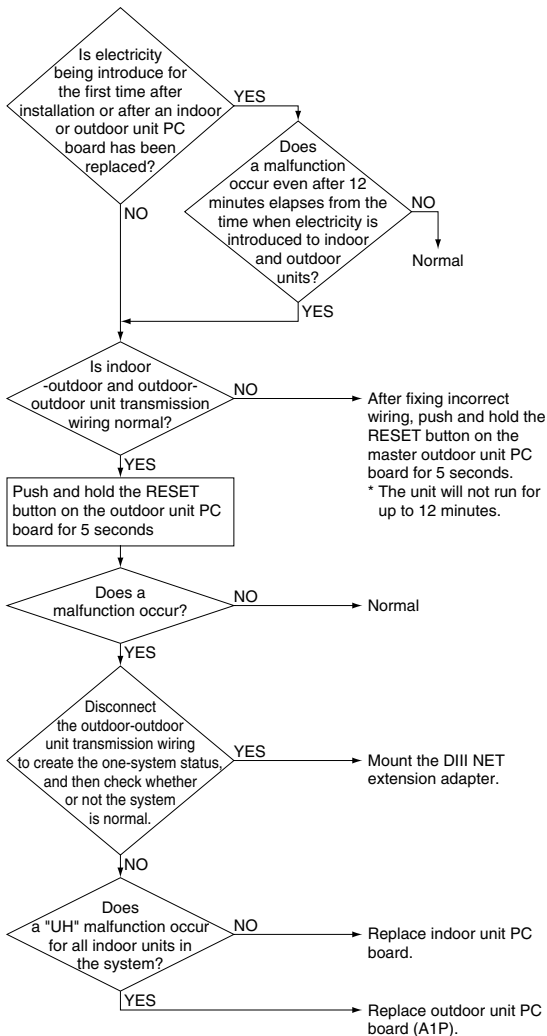

UH

(59) Malfunction of Transmission Between Central Remote Controller and Indoor Unit

Remote Controller Display

UE

Applicable Models

VRV II and III-S (50Hz) Series

Method of Malfunction Detection

Microcomputer checks if transmission between indoor unit and central remote controller is normal.

Malfunction Decision Conditions

When transmission is not carried out normally for a certain amount of time

Supposed Causes

- Malfunction of transmission between optional controllers for centralized control and indoor unit
- Connector for setting master controller is disconnected.
- Failure of PC board for central remote controller
- Defect of indoor unit PC board

Troubleshooting



Caution

Be sure to turn off power switch before connect or disconnect connector, or parts damage may be occurred.

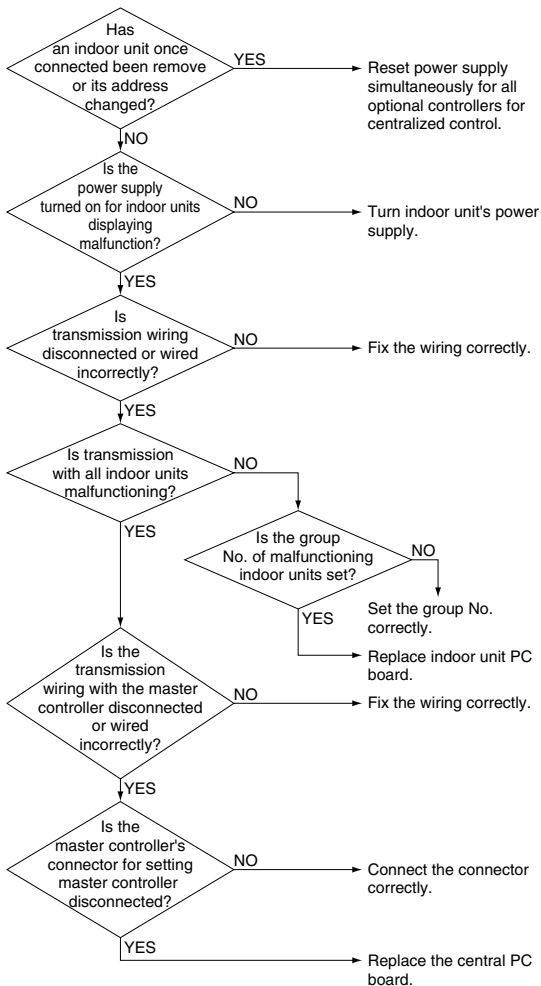

(60) PC Board Defect

Remote Controller Display



Applicable Models

VRV II, II-S, WII and III-S Series

Supposed Causes

- Defect of central remote controller PC board

Troubleshooting

Replace the central remote controller PC board.

Remote Controller Display

M1

Applicable Models

VRV III Series
Intelligent Touch Controller
Central remote controller
Schedule timer

Method of Malfunction Detection

Detect an abnormality in the DIII-NET polarity circuit.

Malfunction Decision Conditions

When + polarity and - polarity are detected at the same time.

Supposed Causes

- Defect of central remote controller PC board
- Defect of Intelligent Touch Controller PC board
- Defect of Schedule timer PC board

M1

Troubleshooting

Replace the central remote controller.



Caution

Be sure to turn off power switch before connect or disconnect connector, or parts damage may be occurred.

Turn ON the power supply of the central equipment with M1 displayed once again.

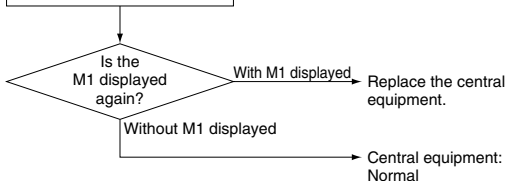

It is supposed that the malfunction results from external factors (e.g. noises) from other equipment.

(61) Malfunction of Transmission Between Optional Controllers for Centralized Control

Remote Controller Display

M8

Applicable Models

VRV II, II-S, WII and III-S Series

Centralized remote controller

Supposed Causes

- Malfunction of transmission between optional controllers for centralized control
- Defect of PC board of optional controllers for centralized control

M1

M8

Troubleshooting



Caution

Be sure to turn off power switch before connect or disconnect connector, or parts damage may be occurred.

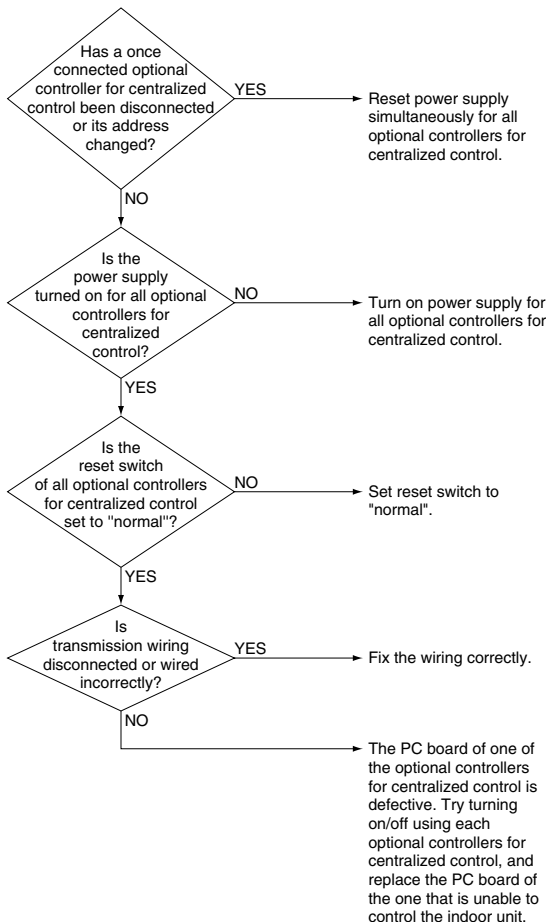

Remote Controller Display

M8

Applicable Models

VRV III Series

Method of Malfunction Detection

Detect the malfunction according to DIII-NET transmission data. (The system will be automatically reset.)

Malfunction Decision Conditions

When no master controller is present at the time of the startup of slave controller.

When the centralized controller, which was connected once, shows no response.

M8

Supposed Causes

- Malfunction of transmission between optional controllers for centralized control
- Defect of PC board of optional controllers for centralized control

Troubleshooting



Caution

Be sure to turn off power switch before connect or disconnect connector, or parts damage may be occurred.

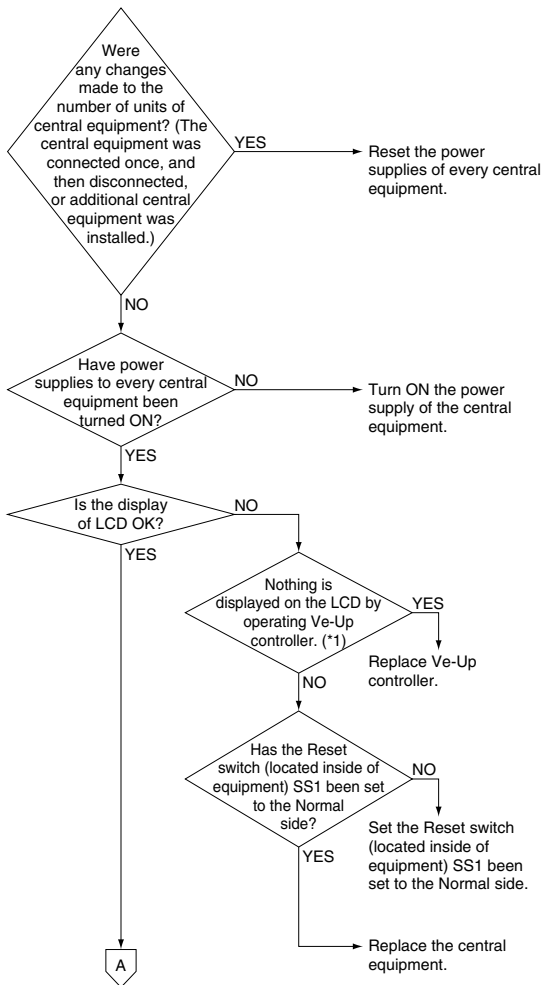

**Caution**

Be sure to turn off power switch before connect or disconnect connector, or parts damage may be occurred.

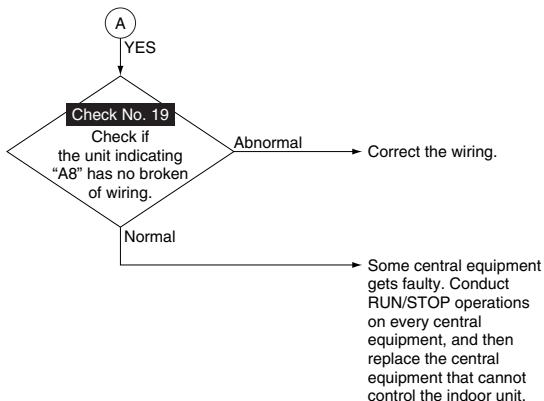
**M8**

Refer to Check No. 19 on page 398.

- *1: Display screen control using Ve-Up controller : When the screen displays nothing by touching the screen, adjust the contrast volume.

Remote Controller Display

M8

Applicable Models

VRV III (60Hz) Series
Intelligent Touch Controller
Central remote controller
Schedule timer

Method of Malfunction Detection

Detect the malfunction according to DIII-NET transmission data. (The system will be automatically reset.)

Malfunction Decision Conditions

When no master controller is present at the time of the startup of slave controller.
When the centralized controller, which was connected once, shows no response.

Supposed Causes

- Malfunction of transmission between optional controllers for centralized control
- Defect of PC board of optional controllers for centralized control

Troubleshooting



Caution

Be sure to turn off power switch before connect or disconnect connector, or parts damage may be occurred.

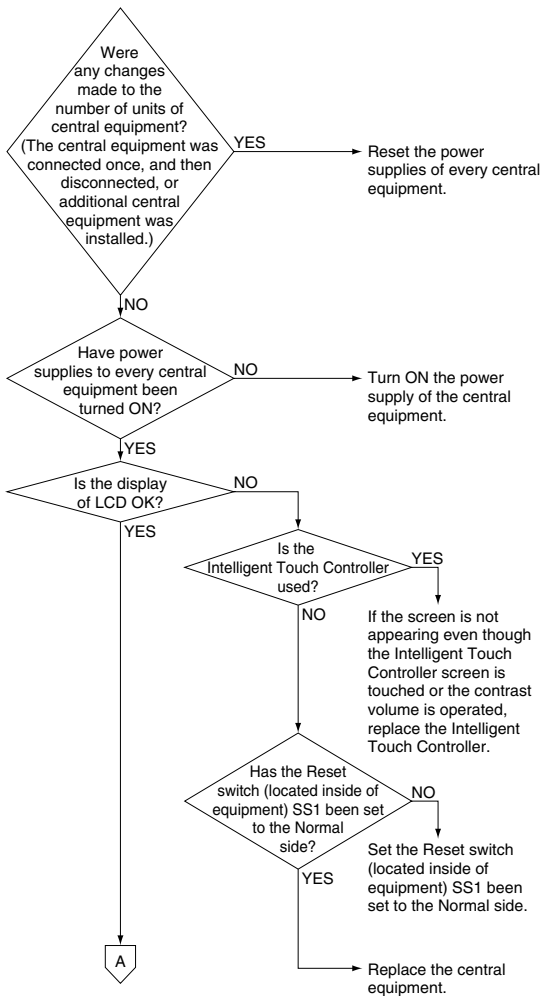

M8

**Caution**

Be sure to turn off power switch before connect or disconnect connector, or parts damage may be occurred.

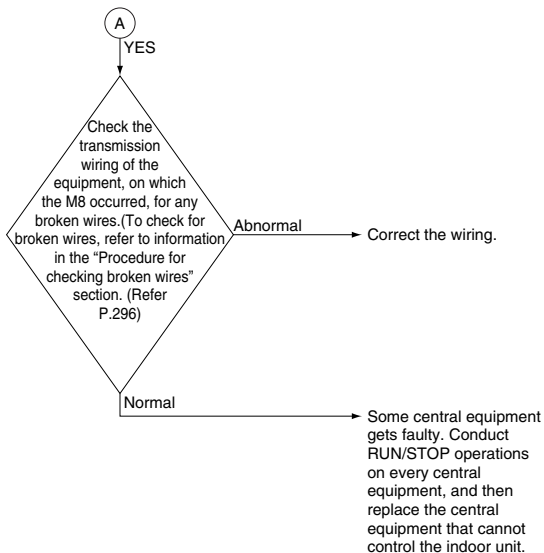

(62) Improper Combination of Optional Controllers for Centralized Control

Remote Controller Display

MR

Applicable Models

VRV II, II-S, WII and III-S Series
Centralized remote controller

Supposed Causes

- Improper combination of optional controllers for centralized control
- More than one master controller is connected
- Defect of PC board of optional controller for centralized control

M8

MA

Troubleshooting



Caution

Be sure to turn off power switch before connect or disconnect connector, or parts damage may be occurred.

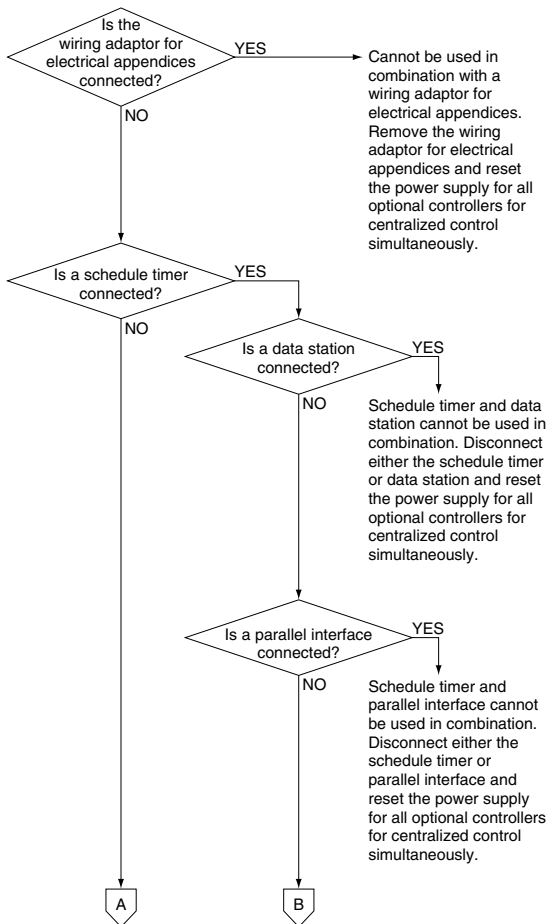

**Caution**

Be sure to turn off power switch before connect or disconnect connector, or parts damage may be occurred.

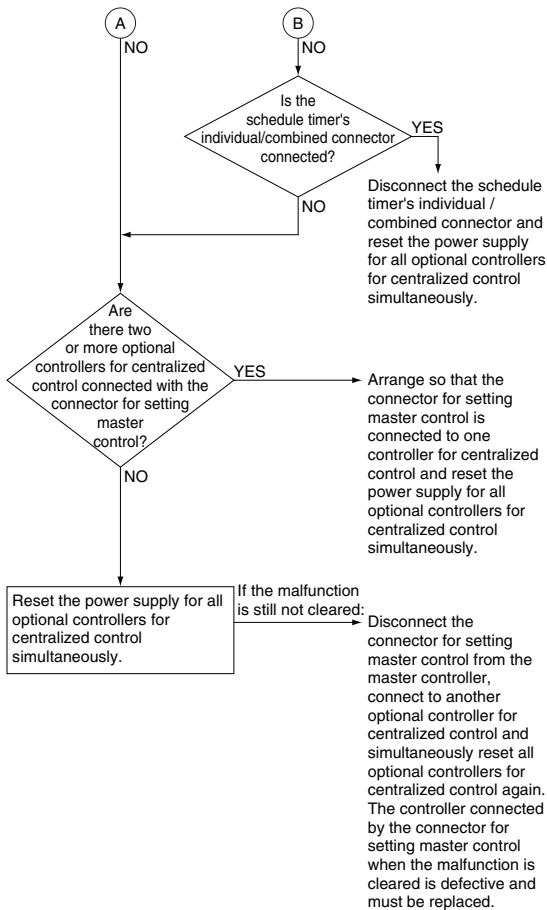
**MA**

Remote Controller Display



Applicable Models

VRV III Series
Intelligent touch controller
Central remote controller
Schedule timer

Method of Malfunction Detection

Detect the malfunction according to DIII-NET transmission data.

Malfunction Decision Conditions

When the schedule timer is set to individual use mode, other central component is present.
When multiple master controller are present.
When the remote control adapter is present.

Supposed Causes

- Improper combination of optional controllers for centralized control
- More than one master controller is connected
- Defect of PC board of optional controller for centralized control

Troubleshooting



Caution

Be sure to turn off power switch before connect or disconnect connector, or parts damage may be occurred.

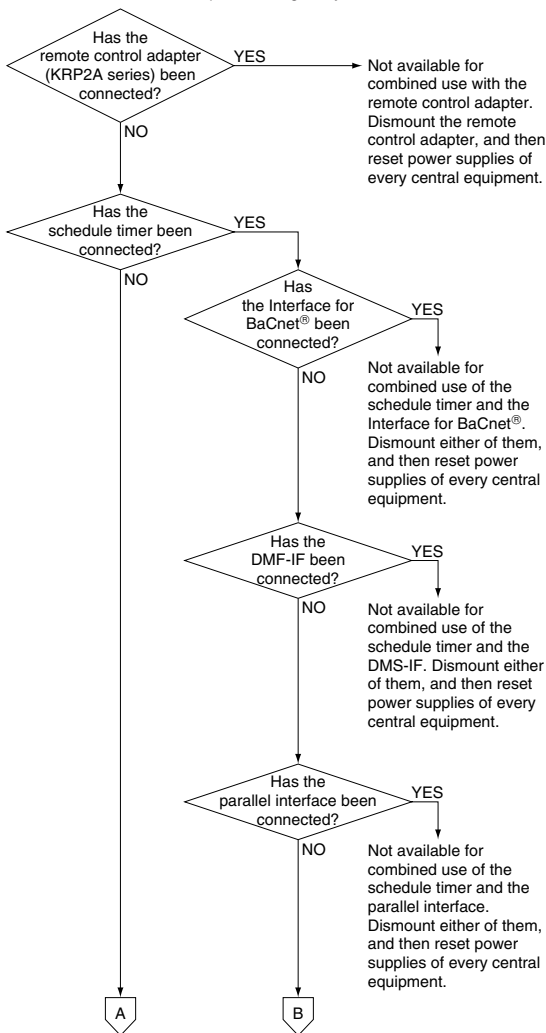

MA



Caution

Be sure to turn off power switch before connect or disconnect connector, or parts damage may be occurred.

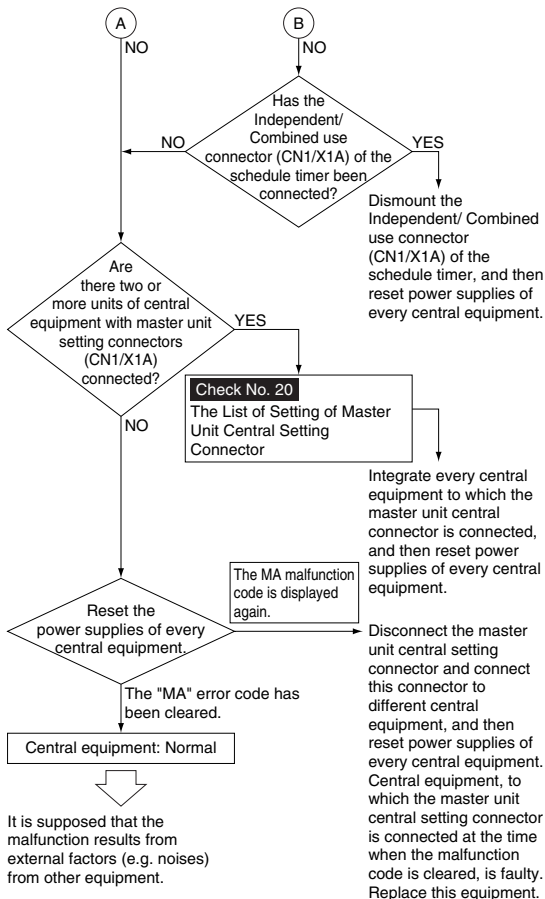

Refer to Check No. 20 on page 400.

(63) Address Duplication, Improper Setting

Remote Controller Display



Applicable Models

VRV II, II-S, WII and III-S Series
Contra remote controller

Supposed Causes

- Address duplication of centralized remote controller

Troubleshooting



Caution

Be sure to turn off power switch before connect or disconnect connector, or parts damage may be occurred.

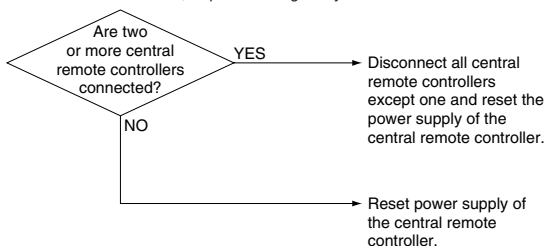

MA

MC

Remote Controller Display



Applicable Models

VRV III Series
Intelligent Touch Controller
Central remote controller
Schedule timer

Method of Malfunction Detection

Detect the malfunction according to DIII-NET transmission data.

Malfunction Decision Conditions

- Two or more units of central remote controllers and Intelligent Touch Controllers are connected, and all of them are set to master unit central setting or slave unit central setting.
- Two units of schedule timers are connected.

Supposed Causes

- Address duplication of centralized controller

Troubleshooting



Caution

Be sure to turn off power switch before connect or disconnect connector, or parts damage may be occurred.

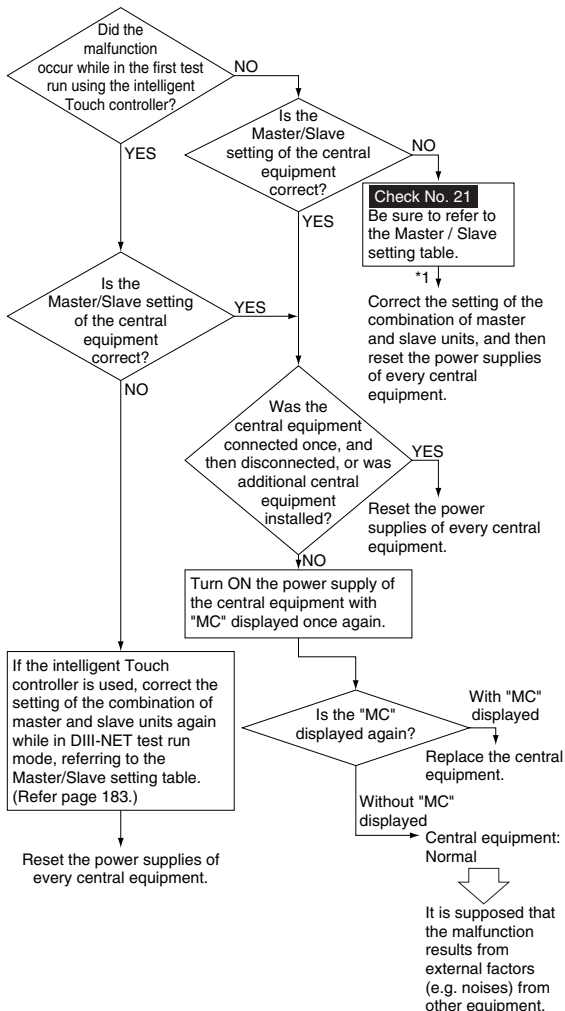

MC



Refer to Check No. 21 on page 401.

Check 1

- Coil check method for the moving part of the electronic expansion valve
Disconnect the electronic expansion valve from the PC board and check the continuity between the connector pins.

(Normal)

Pin No.	1. White	2. Yellow	3. Orange	4. Blue	5. Red	6. Brown
1. White		×	◎	×	○	×
2. Yellow			×	◎	×	○
3. Orange				×	○	×
4. Blue					×	○
5. Red						×
6. Brown						

◎ : Continuity Approx. 300Ω

○ : Continuity Approx. 150Ω

× : No continuity

Check 2 Thermistor Resistance / Temperature Characteristics

Outdoor unit for fin thermistor

R1T

(kΩ)

T°C	0.0
-10	-
-8	-
-6	88.0
-4	79.1
-2	71.1
0	64.1
2	57.8
4	52.3
6	47.3
8	42.9
10	38.9
12	35.3
14	32.1
16	29.2
18	26.6
20	24.3
22	22.2
24	20.3
26	18.5
28	17.0
30	15.6
32	14.2
34	13.1
36	12.0
38	11.1
40	10.3
42	9.5
44	8.8

T°C	0.0
46	8.2
48	7.6
50	7.0
52	6.7
54	6.0
56	5.5
58	5.2
60	4.79
62	4.46
64	4.15
66	3.87
68	3.61
70	3.37
72	3.15
74	2.94
76	2.75
78	2.51
80	2.41
82	2.26
84	2.12
86	1.99
88	1.87
90	1.76
92	1.65
94	1.55
96	1.46
98	1.38

Except VRVIII-S Series

Indoor unit	For air suction	R1T
	For liquid pipe	R2T
	For gas pipe	R3T
Outdoor unit	For outdoor air	R1T
	For coil	R2T
	For suction pipe	R4T
	For Receiver gas pipe	R5T

For VRVIII-S Series

Indoor unit	For air suction	R1T
	For liquid pipe	R2T
	For gas pipe	R3T
Outdoor unit	For outdoor air	R1T
	For suction pipe 1	R3T
	For heat exchanger	R4T
	For suction pipe 2	R5T
	For Subcooling heat exchanger outlet	R6T
	For Liquid pipe	R7T

Outdoor Unit Thermistors for Discharge Pipe (R3T, R31~33T)

(kΩ)

T°C	0.0	0.5	T°C	0.0	0.5	T°C	0.0	0.5
0	640.44	624.65	50	72.32	70.96	100	13.35	13.15
1	609.31	594.43	51	69.64	68.34	101	12.95	12.76
2	579.96	565.78	52	67.06	65.82	102	12.57	12.38
3	552.00	538.63	53	64.60	63.41	103	12.20	12.01
4	525.63	512.97	54	62.24	61.09	104	11.84	11.66
5	500.66	488.67	55	59.97	58.87	105	11.49	11.32
6	477.01	465.65	56	57.80	56.75	106	11.15	10.99
7	454.60	443.84	57	55.72	54.70	107	10.83	10.67
8	433.37	423.17	58	53.72	52.84	108	10.52	10.36
9	413.24	403.57	59	51.98	50.96	109	10.21	10.06
10	394.16	384.98	60	49.96	49.06	110	9.92	9.78
11	376.05	367.35	61	48.19	47.33	111	9.64	9.50
12	358.88	350.62	62	46.49	45.67	112	9.36	9.23
13	342.58	334.74	63	44.86	44.07	113	9.10	8.97
14	327.10	319.66	64	43.30	42.54	114	8.84	8.71
15	312.41	305.33	65	41.79	41.06	115	8.59	8.47
16	298.45	291.73	66	40.35	39.65	116	8.35	8.23
17	285.18	278.80	67	38.96	38.29	117	8.12	8.01
18	272.58	266.51	68	37.63	36.98	118	7.89	7.78
19	260.60	254.72	69	36.34	35.72	119	7.68	7.57
20	249.00	243.61	70	35.11	34.51	120	7.47	7.36
21	238.36	233.14	71	33.92	33.35	121	7.26	7.16
22	228.05	223.08	72	32.78	32.23	122	7.06	6.97
23	218.24	213.51	73	31.69	31.15	123	6.87	6.78
24	208.90	204.39	74	30.63	30.12	124	6.69	6.59
25	200.00	195.71	75	29.61	29.12	125	6.51	6.42
26	191.53	187.44	76	28.64	28.16	126	6.33	6.25
27	183.46	179.57	77	27.69	27.24	127	6.16	6.08
28	175.77	172.06	78	26.79	26.35	128	6.00	5.92
29	168.44	164.90	79	25.91	25.49	129	5.84	5.76
30	161.45	158.08	80	25.07	24.66	130	5.69	5.61
31	154.79	151.57	81	24.26	23.87	131	5.54	5.46
32	148.43	145.37	82	23.48	23.10	132	5.39	5.32
33	142.37	139.44	83	22.73	22.36	133	5.25	5.18
34	136.59	133.79	84	22.01	21.65	134	5.12	5.05
35	131.06	128.39	85	21.31	20.97	135	4.98	4.92
36	125.79	123.24	86	20.63	20.31	136	4.86	4.79
37	120.76	118.32	87	19.98	19.67	137	4.73	4.67
38	115.95	113.62	88	19.36	19.05	138	4.61	4.55
39	111.35	109.13	89	18.75	18.46	139	4.49	4.44
40	106.96	104.84	90	18.17	17.89	140	4.38	4.32
41	102.76	100.73	91	17.61	17.34	141	4.27	4.22
42	98.75	96.81	92	17.07	16.80	142	4.16	4.11
43	94.92	93.06	93	16.54	16.29	143	4.06	4.01
44	91.25	89.47	94	16.04	15.79	144	3.96	3.91
45	87.74	86.04	95	15.55	15.31	145	3.86	3.81
46	84.38	82.75	96	15.08	14.85	146	3.76	3.72
47	81.16	79.61	97	14.62	14.40	147	3.67	3.62
48	78.09	76.60	98	14.18	13.97	148	3.58	3.54
49	75.14	73.71	99	13.76	13.55	149	3.49	3.45
50	72.32	70.96	100	13.35	13.15	150	3.41	3.37

Check 3 Voltage measurement point

High pressure sensor

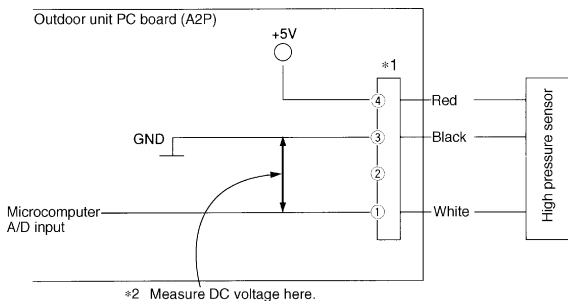

Low pressure sensor

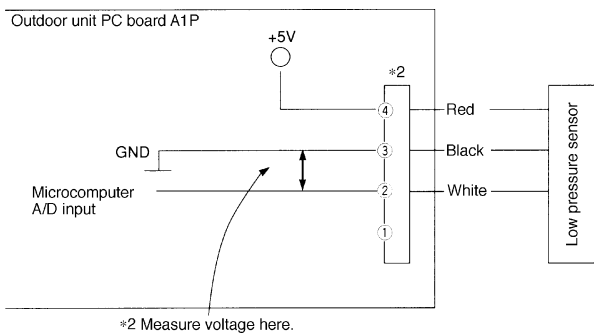

	*1 (Red)	*2 (Blue)
VRV II/W II	X46A	X45A
VRV III	X32A	X31A
VRV III-S	X17A	X18A

Check 4 Pressure Sensor

$P_H = 1.38V - 0.69$

$P_L = 0.57V - 0.28$

P_H : High pressure (MPa)

P_L : Low pressure (MPa)

V : Voltage (V)

P_H : Detected Pressure [High Side] MPa

P_L : Detected Pressure [Low Side] MPa

V_H : Output Voltage [High Side] VDC

V_L : Output Voltage [Low Side] VDC

Detected Pressure

P_H, P_L
(kg/cm²) MPa

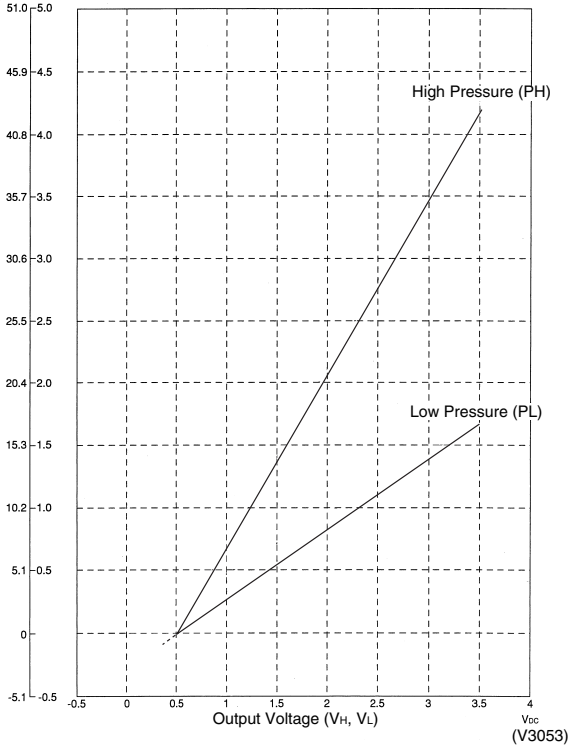

Check 5 Check for causes of rise in high pressure

Except VRV WII

Referring to the Fault Tree Analysis (FTA) shown below, probe the faulty points.

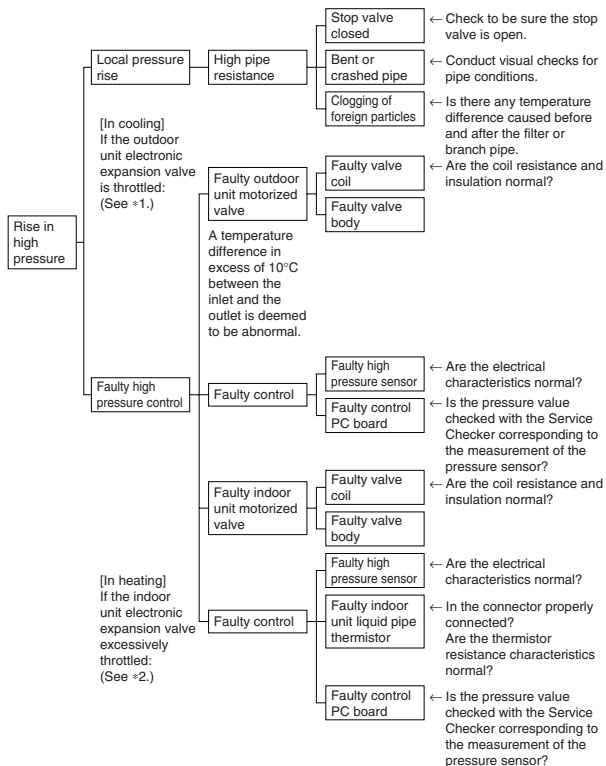

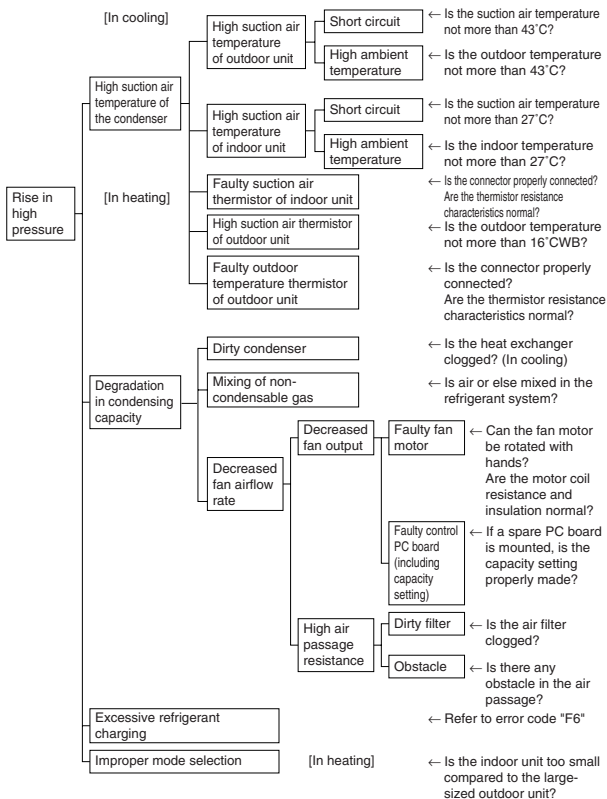

*1: In cooling, it is normal if the outdoor unit electronic expansion valve (EVM) is fully open.

*2: In heating, the indoor unit electronic expansion valve is used for "subcooled degree control".

For VRV VII

Referring to the Fault Tree Analysis (FTA) shown below, identify the faulty points.

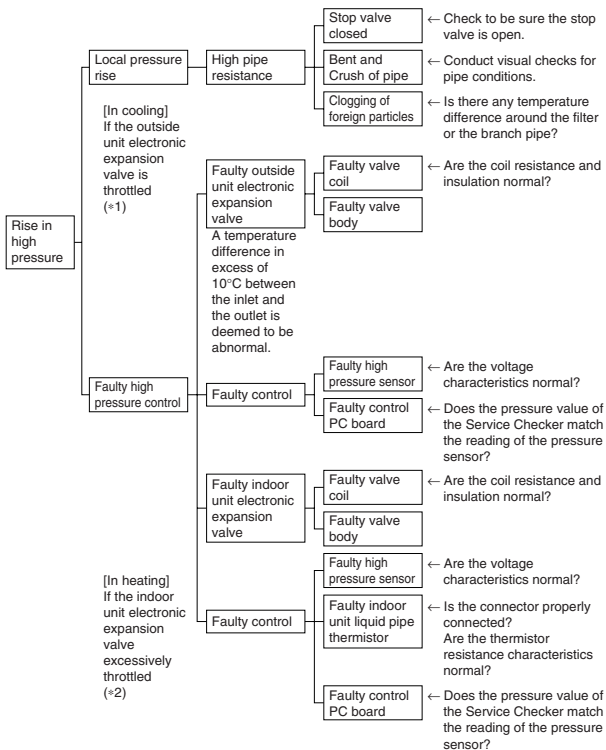

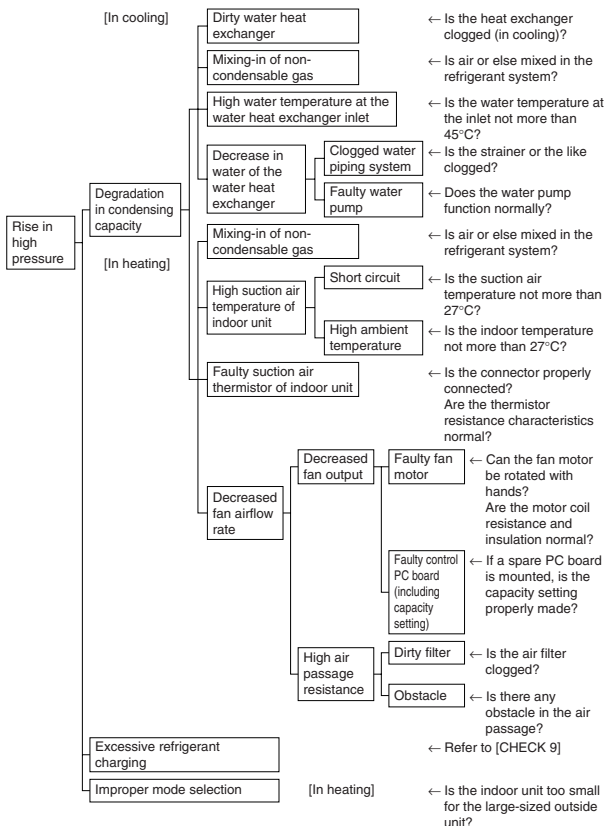

*1: In cooling, the outside unit electronic expansion valve (Y1E) is fully open in normal condition.

*2: In heating, the indoor unit electronic expansion valve is used for “subcooled degree control”.

Check 6 Check for causes of drop in low pressure

Except VRV WII

Referring to the Fault Tree Analysis (FTA) shown below, probe the faulty points.

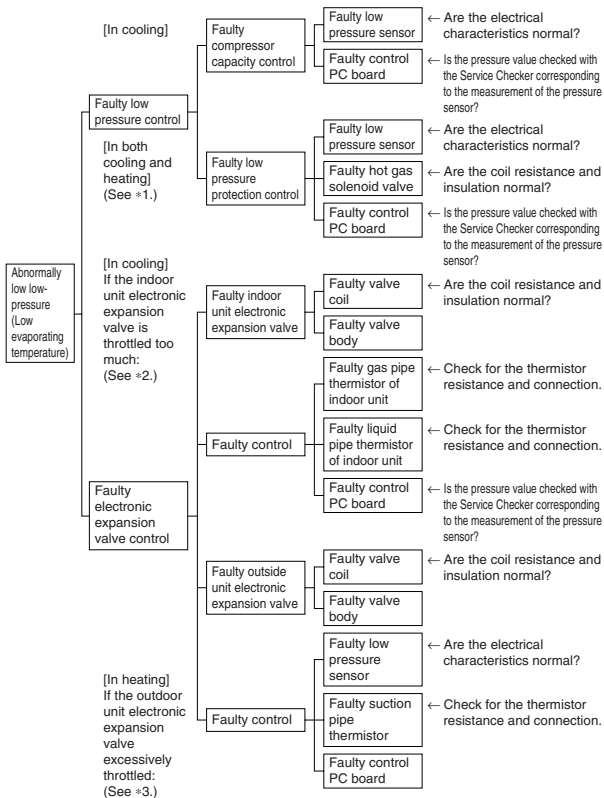

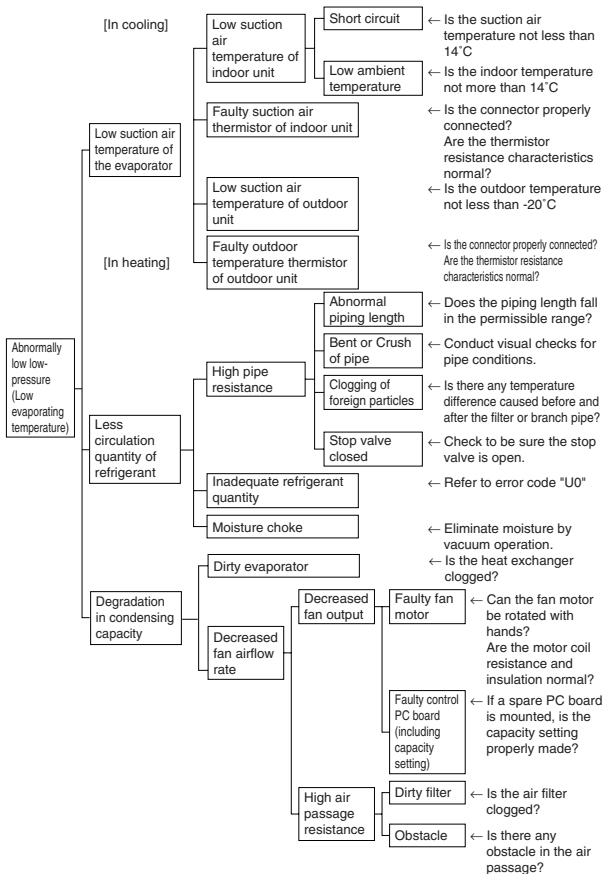

- *1: The "low pressure protection control" includes low pressure protection control and hot gas bypass control.
- *2: In cooling, the indoor unit electronic expansion valve is used for "superheated degree control".
- *3: In heating, the outdoor unit electronic expansion valve (EVM) is used for "superheated degree control of outdoor unit heat exchanger".

For VRV VII

Referring to the Fault Tree Analysis (FTA) shown below, identify the faulty points.

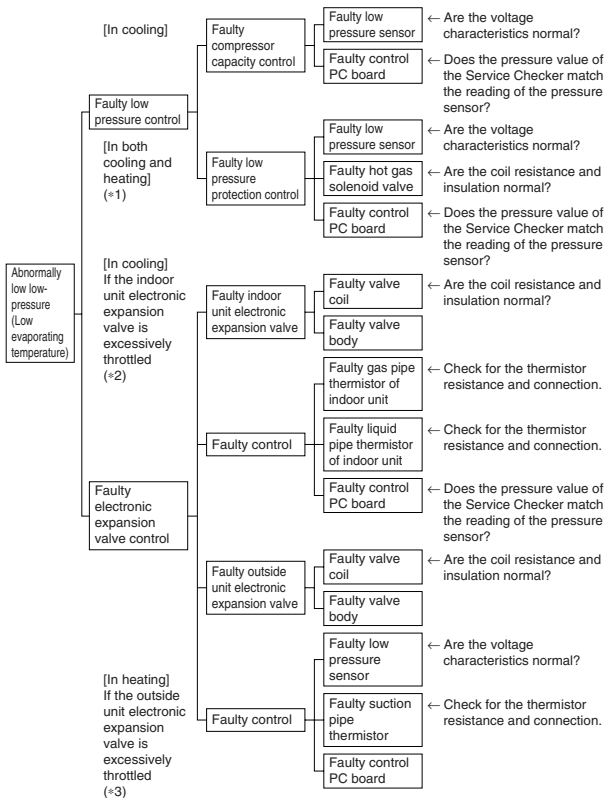

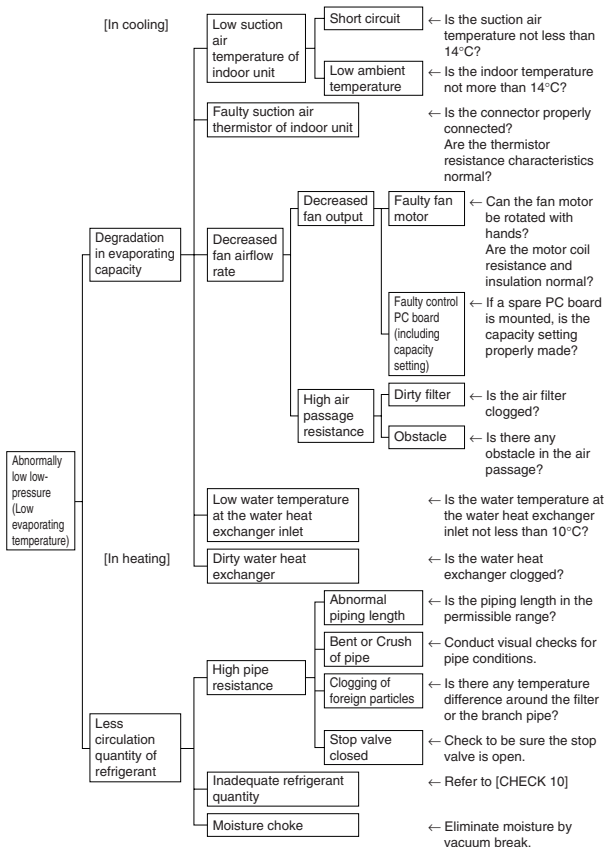

- *1: The “low pressure protection control” includes low pressure drop control and hot gas bypass control.
- *2: In cooling, the indoor unit electronic expansion valve is used for “superheated degree control”.
- *3: In heating, the outdoor unit electronic expansion valve (Y1E) is used for “superheated degree control of outside unit heat exchanger”.

Check 7 Check for causes of overheat operation For VRV II

Referring to the Fault Tree Analysis (FTA) shown below, identify the faulty points.

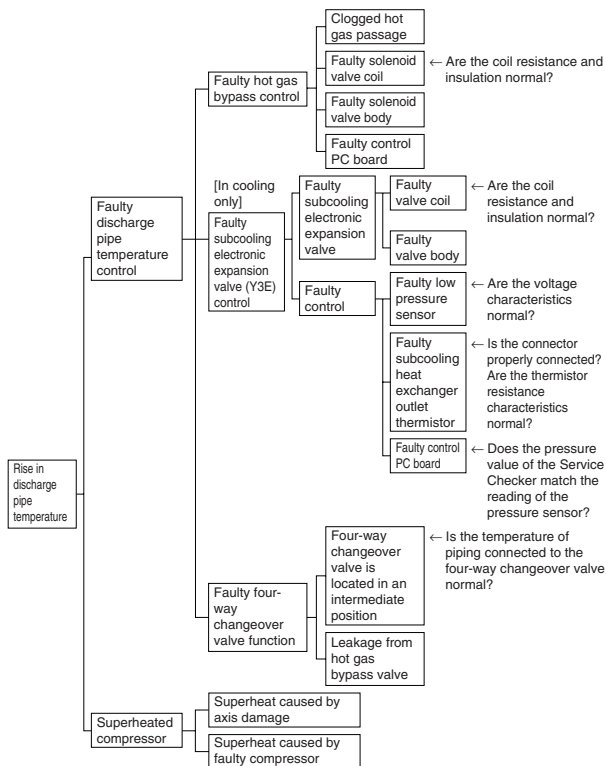

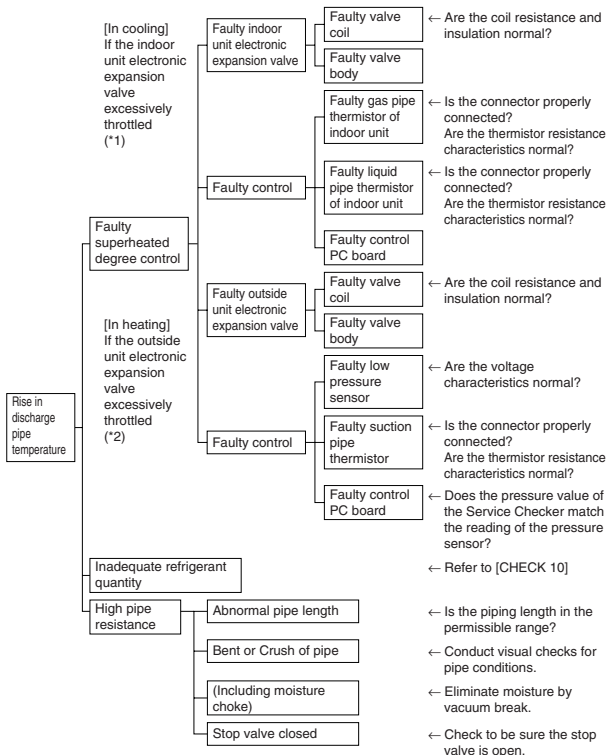

*1: In cooling, the indoor unit electronic expansion valve is used for “superheated degree control”.

*2: In heating, the outside unit electronic expansion valve (Y1E) is used for “superheated degree control.”

*3: Reference values for superheated degree to be used in the judgment of overheat operation ① Suction gas superheated degree: 10°C or more ② Discharge gas superheated degree: 45°C or more, excluding when it is immediately after startup, under drop control or other specific conditions.

(The values above must be used only for reference purposes. Even it is operated within the range above, operation may be normal in other conditions.)

For VRV III

Identify the defective points referring to the failure factor analysis (FTA) as follows.

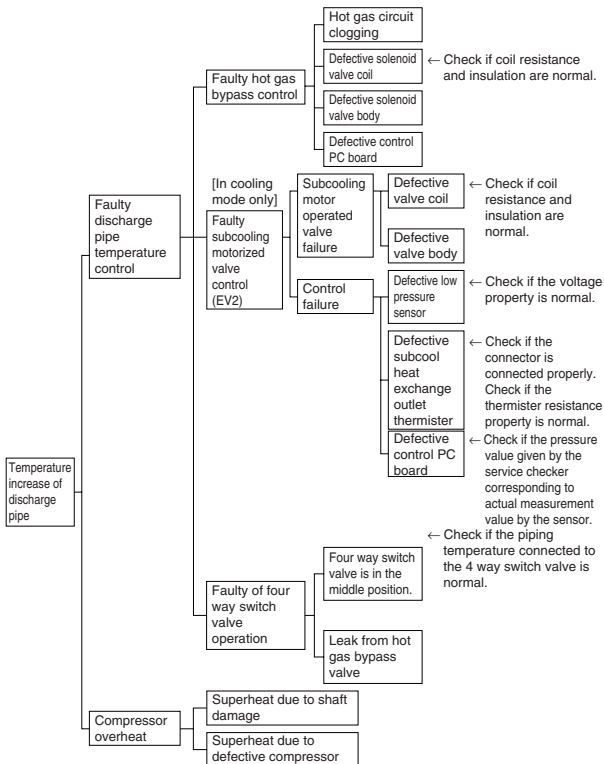

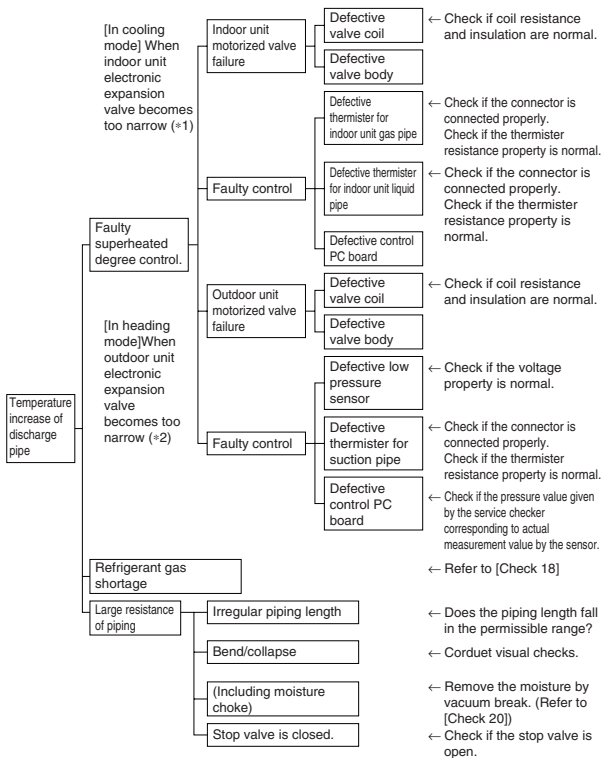

- *1: "Superheating temperature control" in cooling mode is conducted by indoor unit electronic expansion valve.
- *2: Superheating temperature control in heating mode is conducted by outdoor unit electronic expansion valve (EVM).
- *3: Judgment criteria of superheat operation:
 - ① Suction gas superheating temperature: 10 degrees and over.
 - ② Discharge gas superheating temperature: 45 degrees and over, except for immediately after starting and drooping control, etc.. (Use the above stated values as a guide. Depending on the other conditions, the unit may be normal despite the values within the above scope.)

Check 8 Check for causes of wet operation

Referring to the Fault Tree Analysis (FTA) shown below, identify the faulty points.

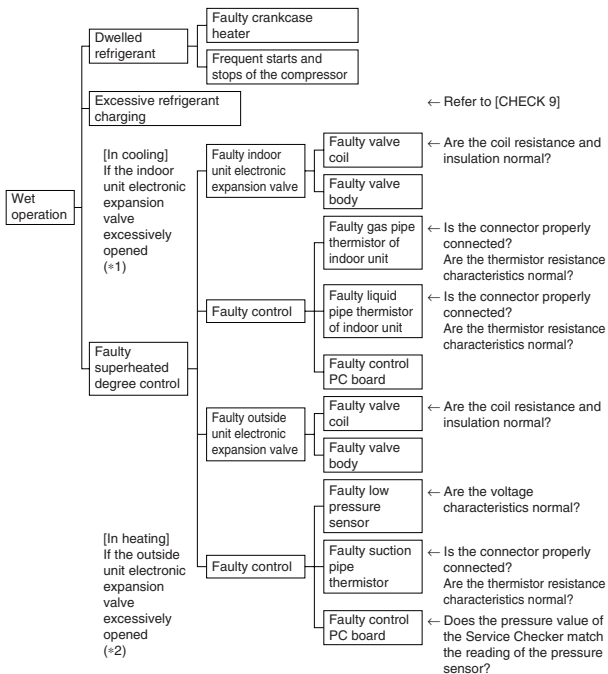

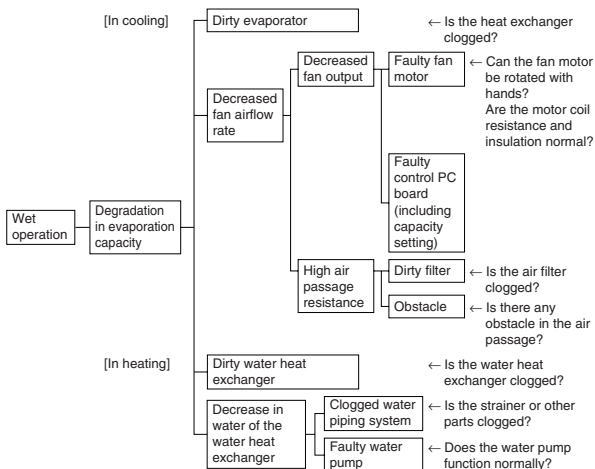

- *1: In cooling, the indoor unit electronic expansion valve is used for “superheated degree control”.
- *2: In heating, the outside unit electronic expansion valve (Y1E) is used for “superheated degree control”.
- *3: Reference values for superheated degree to be used in the judgment of wet operation ① Suction gas superheated degree: 3°C or less ② Discharge gas superheated degree: 15°C or less, excluding when it is immediately after startup, under drop control or other specific conditions.
(The values above must be used only for reference purposes. Even it is operated within the range above, operation may be normal in other conditions.)

Check 9 Check for excessive refrigerant charging

In case of the VRV, judgment must be made based on operation conditions in relation to pressure control and electronic expansion valve control. Refer to the following criteria to make such decisions.

Diagnosis of excessive refrigerant charging

- (1) Since high pressure rises, overload control is carried out and therefore capacity tends to be insufficient.
- (2) Since superheated degree of suction gas decreases (or it starts wet operation), the temperature of the compressor discharge pipe drops too much for pressure applied.
- (3) Since the subcooling degree of condensate liquid increases, the temperature of air blown through subcooled part decreases in heating.

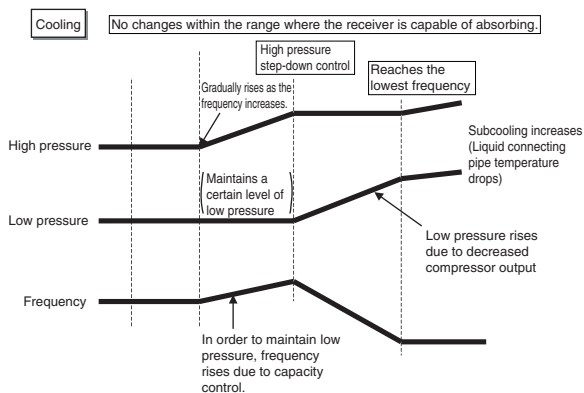

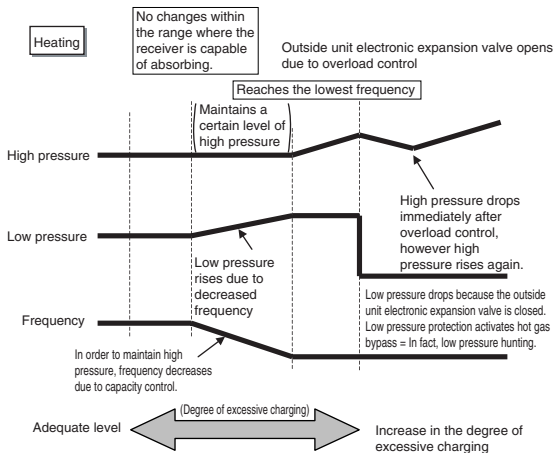

Check 10 Check for inadequate refrigerant quantity

In case of the VRV, judgment must be made based on operation conditions in relation to pressure control and electronic expansion valve control. Refer to the following criteria to make such decisions.

Diagnosis of inadequate refrigerant

- (1) The superheated degree of suction gas increases and temperature of compressor discharge gas rises.
- (2) The superheated degree of suction gas increases and the electronic expansion valve slightly opens.
- (3) With low pressure, cooling capacity (heating capacity) is unavailable.

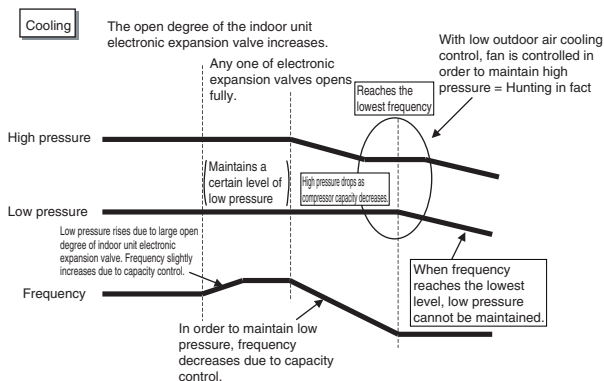

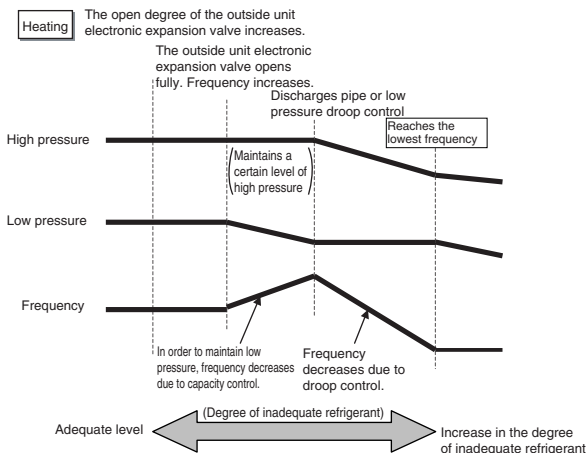

Check 11 Check on connector of fan motor (Power supply cable)

(1) Turn off the power supply.

Measure the resistance between phases of U,V,W at the motor side connectors (three-core wire) to check that the values are balanced and there is no short circuiting, while connector or relay connector is disconnected.

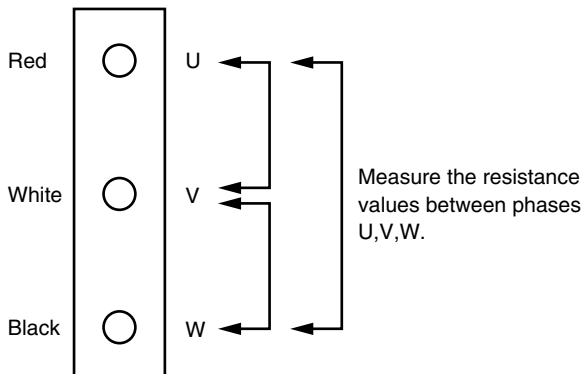

Check 12

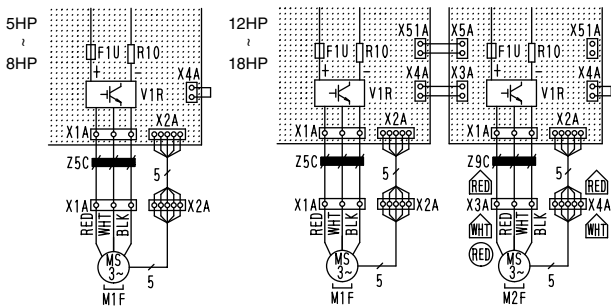

Check 13

- (1) Turn off the power supply.
- (2) Measure the resistance between Vcc and each phase of U,V,W, and GND and each phase at the motor side connectors (five-core wire) to check that the values are balanced within the range of $\pm 20\%$, while connector or relay connector is disconnected. Furthermore, to use a multiple meter for measurement, connect the probe of negative pole to Vcc and that of positive pole to GND.

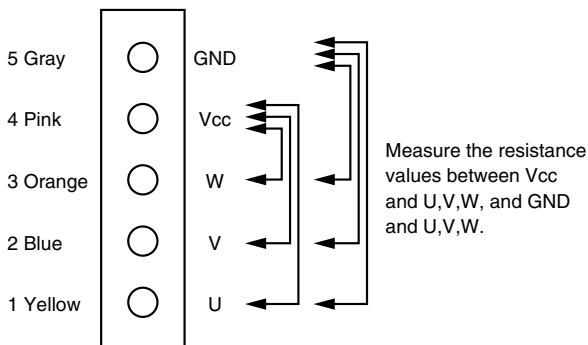

Check 14 Check on pulse input of position signal of fan inverter PC board

- (1) Disconnect the connector X2A while power supply OFF and operation OFF.
- (2) Is the voltage between pins No. 4 and 5 on X2A approx. 15 V after power supply is turned on?
- (3) Connect the connector X2A while power supply OFF and operation OFF.
- (4) Check below conditions when the fan motor is rotated one turn manually under the condition of operation OFF after power supply is turned ON.
 Are the pulse (approx. 0 V and 5 V) generated 4 times between No. 1 and 5 on X2A?
 Are the pulse (approx. 0 V and 5 V) generated 4 times between No. 2 and 5 on X2A?
 Are the pulse (approx. 0 V and 5 V) generated 4 times between No. 3 and 5 on X2A?

The condition (2) dose not appear → Faulty PC board → Replacing the PC board
 The conditions (4) do not appear → Faulty hall IC → Replacing fan motor of outdoor unit

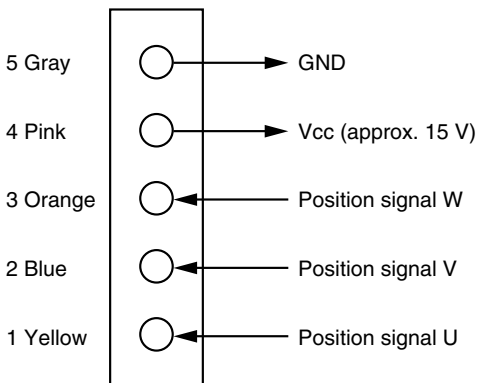

Check 15 Check for Fan Motor Connector

- (1) Turn the power supply off.
- (2) With the fan motor connector disconnected, measure the resistance between each pin, then make sure that the resistance is more than the value mentioned in the following table.

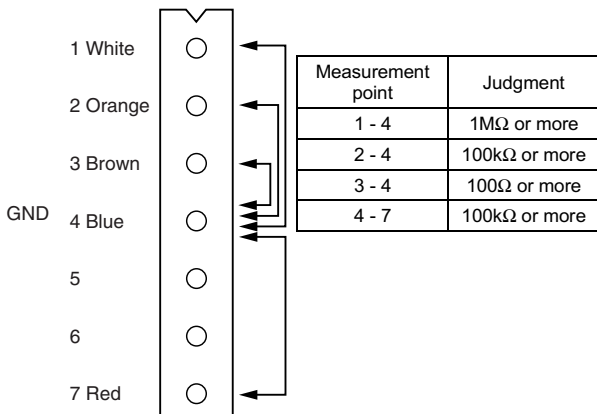

Check 16

Make measurement of resistance between the connector pins, and then make sure the resistance falls in the range of 40 to 50Ω.



Measuring points	Judgment criteria
1 - 6	40~50Ω
2 - 6	
3 - 6	
4 - 6	

Check 17 Method of Checking The Inverter's Power Transistors and Diode Modules

Checking failures in power semiconductors mounted on inverter PC board

Check the power semiconductors mounted on the inverter PC board by the use of a multiple tester.

<Items to be prepared>

- Multiple tester : Prepare the analog type of multiple tester.
For the digital type of multiple tester, those with diode check function are available for the checking.

<Test points>

- Turn OFF the power supply. Then, after a lapse of 10 minutes or more, make measurement of resistance.

<Preparation>

- To make measurement, disconnect all connectors and terminals.

Inverter PC board

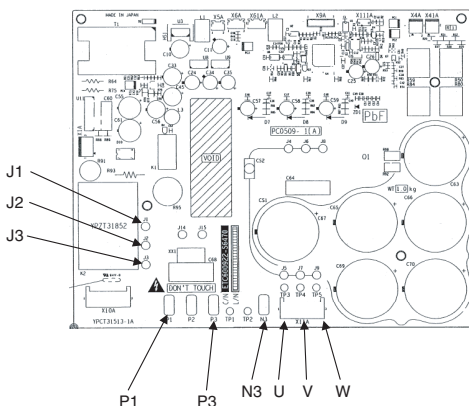

Electronic circuit

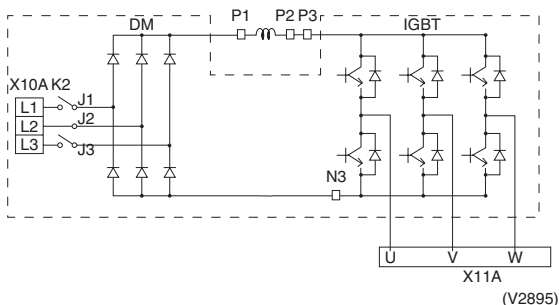

■ According to the checking aforementioned, it is probed that the malfunction results from the faulty inverter. The following section describes supposed causes of the faulty inverter.

- Faulty compressor (ground leakage)
- Faulty fan motor (ground leakage)
- Entry of conductive foreign particles
- Abnormal voltage (e.g. overvoltage, surge (thunder), or unbalanced voltage)

In order to replace the faulty inverter, be sure to check for the points aforementioned.

1. Power module checking

When using the analog type of multiple tester, make measurement in resistance measurement mode in the $\times 1k\Omega$ range.

No.	Measuring point		Criterion	Remark
	+	-		
1	P3	U	2 to 15k Ω	
2	P3	V		
3	P3	W		
4	U	P3	Not less than 15k Ω (including)	It may take time to determine the resistance due to capacitor charge or else.
5	V	P3		
6	W	P3		
7	N3	U		
8	N3	V		
9	N3	W		
10	U	N3	2 to 15k Ω	
11	V	N3		
12	W	N3		

When using the digital type of multiple tester, make measurement in diode check mode ($\rightarrow|$).

No.	Measuring point		Criterion	Remark
	+	-		
1	P3	U	Not less than 1.2V (including)	It may take time to determine the voltage due to capacitor charge or else.
2	P3	V		
3	P3	W		
4	U	P3	0.3 to 0.7V	
5	V	P3		
6	W	P3		
7	N3	U		
8	N3	V		
9	N3	W		
10	U	N3	Not less than 1.2V (including)	It may take time to determine the voltage due to capacitor charge or else.
11	V	N3		
12	W	N3		

2. Diode module checking

When using the analog type of multiple tester, make measurement in resistance measurement mode in the x1k Ω range.

No.	Measuring point		Criterion	Remark
	+	-		
1	P1	J1	2 to 15k Ω	
2	P1	J2		
3	P1	J3		
4	J1	P1	Not less than 15k Ω (including)	It may take time to determine the resistance due to capacitor charge or else.
5	J2	P1		
6	J3	P1		
7	N3	J1		
8	N3	J2		
9	N3	J3		
10	J1	N3	2 to 15k Ω	
11	J2	N3		
12	J3	N3		

When using the digital type of multiple tester, make measurement in diode check mode ($\rightarrow|$).

No.	Measuring point		Criterion	Remark
	+	-		
1	P1	J1	Not less than 1.2V (including)	It may take time to determine the voltage due to capacitor charge or else.
2	P1	J2		
3	P1	J3		
4	J1	P1	0.3 to 0.7V	
5	J2	P1		
6	J3	P1		
7	N3	J1		
8	N3	J2		
9	N3	J3		
10	J1	N3	Not less than 1.2V (including)	It may take time to determine the voltage due to capacitor charge or else.
11	J2	N3		
12	J3	N3		

Check 18 Method of Replacing the Inverter's Power Transistors Modules

Checking failures in power semiconductors mounted on inverter PC board

Check the power semiconductors mounted on the inverter PC board by the use of a multiple tester.

<Items to be prepared>

- Multiple tester : Prepare the digital type of multiple tester with diode check function.

<Preparation>

- Turn OFF the power supply. Then, after a lapse of 10 minutes or more, make measurement of resistance.
- To make measurement, disconnect all connectors and terminals.

Inverter PC board

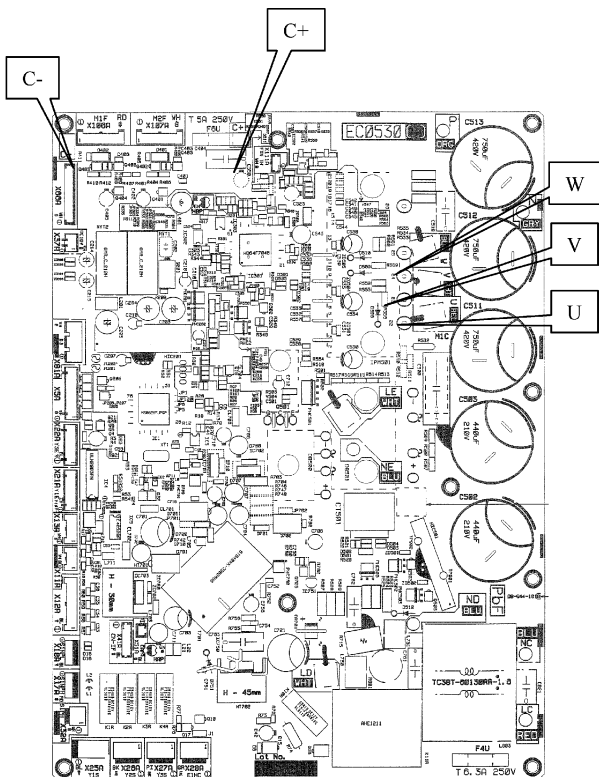

Power module checking

When using the digital type of multiple tester, make measurement in diode check mode.

Tester terminal		Criterion	Remark
+	-		
C+	U	Not less than 0.3V (including ∞)*	It may take time to determine the voltage due to capacitor charge or else.
	V		
	W		
U	C-	Not less than 0.3V (including ∞)*	
V			
W			
U	C+	0.3 to 0.7V (including ∞)*	
V			
W			
C-	U	0.3 to 0.7V (including ∞)*	
	V		
	W		

*There needs to be none of each value variation.

The following abnormalities are also doubted besides the PC board abnormality.

- Faulty compressor (ground fault, ground leakage)
- Faulty fan motor (ground leakage)

Check 19 Broken Wire Check of the Connecting Wires

1. Procedure for checking outdoor-outdoor unit transmission wiring for broken wires

On the system shown below, turn OFF the power supply to all equipment, short-circuit between the outdoor-outdoor unit terminal parts F1 and F2 in the "Outdoor Unit A" that is farthest from the central remote controller, and then conduct continuity checks between the transmission wiring terminal blocks F1 and F2 of the central remote controller using a multiple meter. If there is continuity between the said terminal blocks, the outdoor-outdoor unit transmission wiring has no broken wires in it.

If there is no continuity, the transmission wiring may have broken wires. With the outdoor-outdoor unit terminal parts of the "Outdoor Unit A" short-circuited, conduct continuity checks between the transmission wiring terminal blocks F1 and F2 of the unified ON/OFF controller. If there is no continuity as well, conduct continuity checks between the outdoor-outdoor unit terminal parts of the "Outdoor Unit E", between the outdoor-outdoor unit terminal parts of the "Outdoor Unit D", between the outdoor-outdoor unit terminal parts of the "Outdoor Unit C", ... in the order described, thus identifying the place with continuity. If the place with continuity can be identified, there may be broken wires in places before the said place with continuity.

2. Procedure for checking indoor-outdoor unit transmission wiring for broken wires (for checking the indoor-outdoor unit transmission wiring of the "Outdoor Unit C" for broken wires)

Turn OFF the power supply to all equipment, short-circuit between the indoor-outdoor unit terminal parts F1 and F2 in the "Outdoor Unit C, and then conduct continuity checks between the transmission wirings F1 and F2 of the "Indoor Unit a" that is farthest from the "Outdoor Unit C" using a multiple meter. If there is continuity between the said transmission wirings, the

indoor-outdoor unit transmission wiring has no broken wires in it.

If there is no continuity, the transmission wiring may have broken wires. With the indoor-outdoor unit terminal parts of the "Outdoor Unit C" short-circuited, identify the place with continuity in the transmission wiring of the "Indoor Unit b", transmission wiring of the "Indoor Unit c", and transmission wiring of the "Indoor Unit d" in the order described.

If the place with continuity can be identified, there may be broken wires in places before the said place with continuity.

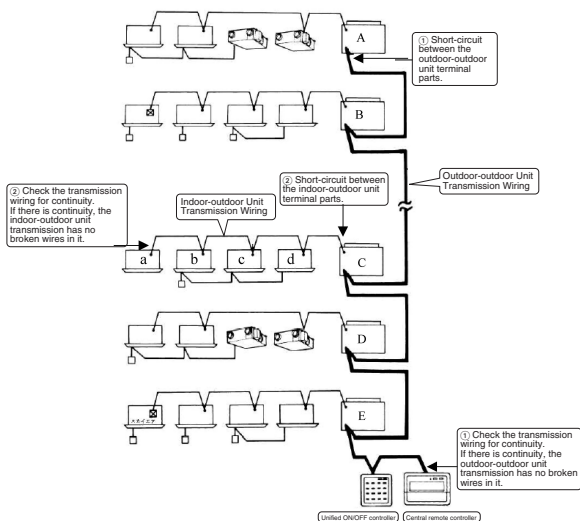

Check 20 Master Unit Central Connector Setting Table

The master unit central setting connector (CN1/X1A) is mounted at the factory.

- To independently use a single unit of the intelligent Touch controller or a single unit of the central remote controller, do not dismount the master unit central setting connector (i.e., use the connector with the factory setting unchanged).
- To independently use the schedule timer, insert an independent-use setting connector. No independent-use setting connector has been mounted at the factory. Insert the connector, which is attached to the casing of the main unit, in the PC board (CN1/X1A). (Independent-use connector=Master unit central setting connector)
- To use two or more central equipment in combination, make settings according to the table shown below.

Pattern	Central equipment connection pattern				Setting of master unit central setting connector(*2)				
	Intelligent Touch controller	Central remote controller	Unified ON/OFF controller	Schedule timer	Intelligent Touch controller	Central remote controller	Unified ON/OFF controller	Schedule timer	
①	1 to 2 units	/	/	× (*1)	Only a single unit: "Provided", Others: "Not provided"	/	/	/	
②	/	/	/	× (*1)	/	/	/	/	
③	1 unit	1 unit	/	× (*1)	Provided	Not provided	/	/	
④	1 to 2 units	/	1 to 8 units	× (*1)	Only a single unit: "Provided", Others: "Not provided"	/	All "Not provided"	/	
⑤	/	/	/	/	/	/	/	/	
⑥	/	1 to 4 units	1 to 16 units	1 unit	/	Only a single unit: "Provided", Others: "Not provided"	All "Not provided"	Not provided	
⑦	/			/	/			/	
⑧	/			/	1 unit			/	Not provided
⑨	/			/	/			/	/
⑩	/	/	1 to 16 units	1 unit	/	Only a single unit: "Provided", Others: "Not provided"	Not provided		
⑪	/	/	/	1 unit	/			Provided	

(*1) The intelligent Touch controller and the schedule timer are not available for combined use.

(*2) The intelligent Touch controller, central remote controller, and the unified ON/OFF controller have been set to "Provided with the master unit central setting connector" at the factory. The schedule timer has been set to "Not provided with the master unit central setting connector" at the factory, which is attached to the casing of the main unit.

Check 21 Master-Slave Unit Setting Table

Combination of Intelligent Touch Controller and Central Remote Controller



*	#1		#2		#3		#4	
	Pattern	1-00-4-15	5-00-8-15	1-00-4-15	5-00-8-15	Master/Slave	Master/Slave	
1	CRC	Master	CRC	Master	CRC	Slave	CRC	Slave
2	CRC	Master	—	—	CRC	Slave	—	—
3	Intelligent Touch controller	Master	—	—	Intelligent Touch controller	Slave	—	—
4	CRC	Master	—	—	Intelligent Touch controller	Slave	—	—
5	Intelligent Touch controller	Master	—	—	CRC	Slave	—	—
6	CRC	Master	—	—	—	—	—	—
7	Intelligent Touch controller	Master	—	—	—	—	—	—

CRC: Central remote controller <DCS302CA61>

Intelligent Touch controller: <DCS601C51>

The patterns marked with "" have nothing to do with those described in the list of Setting of master unit central setting connector.



The air conditioners manufactured by Daikin Industries have received **ISO 9001** certification for quality assurance.

Certificate Number: JMI-0107
JGA-0496
JGA-1402



All Daikin Industries locations and subsidiaries in Japan have received environmental management system standard **ISO 14001** certification.

Daikin Industries, Ltd.
Domestic Group
Certificate Number: ECRN12044

About ISO 14001

ISO 14001 is the standard defined by the International Organization for Standardization (ISO) relating to environmental management systems. Our group has been acknowledged by an internationally accredited compliance organisation as having an appropriate programme of environmental protection procedures and activities to meet the requirements of ISO 14001.

Dealer

DAIKIN INDUSTRIES, LTD.

Head Office:
Umeda Center Bldg., 4-12, Nakazaki-Nishi
2-chome, Kita-ku, Osaka, 530-8323 Japan

Tokyo Office:
JR Shinagawa East Bldg., 18-1, Konan
2-chome, Minato-ku, Tokyo, 108-0075 Japan
<http://www.daikin.com/global/>

©AI rights reserved

*The specifications, designs, and information in this brochure are subject to change without notice.

SI30-701

Printed in Japan 03/2008 AK

Большая библиотека технической документации
<http://splitoff.ru/tehn-doc.html>
каталоги, инструкции, сервисные мануалы, схемы.

